

Store this manual under the car seat, in the designated storage location as shown on the illustration above.

KEEP INSTRUCTIONS FOR FUTURE USE.
Carefully read and understand all instructions and warnings in this manual. Failure to properly use this infant car seat increases the risk of serious injury or death in a sudden stop or crash. Store this manual in the storage location provided on the back of the seat.



EZ LIFT™ INFANT CAR SEAT

Child Weight: **4 to 30 lb (1.8 to 13.6kg).**

Child Height: **29.5" or less (74.9 cm).**

OWNER'S MANUAL



 **babytrend®**
Quality • Comfort • Style

Baby Trend, Inc.
13048 Valley Blvd.
Fontana CA 92335

1-800-328-7363
(8:00am ~ 4:30pm PST).
www.babytrend.com

TABLE OF CONTENTS

WARNINGS TO ALERT YOU TO POSSIBLE DANGERS	3
HOW TO REGISTER YOUR SAFETY SEAT	4
SAFETY INFORMATION	5
3.1 About your child	5
3.2 About your vehicle.....	5
3.3 About Active Air Bags.....	7
3.4 About an unoccupied Safety Seat.....	7
3.5 About this Safety Seat.....	8
3.6 About use as a carrier	8
SELECTING THE BEST LOCATION FOR THE SAFETY SEAT	11
4.1 Overall Considerations in Selecting a Location	11
4.2 Check that the Vehicle Seat Meets the Following Requirements	12
4.3 Check that the Vehicle Seat Belt is Safe to Use	13
SAFETY SEAT FEATURES AND THEIR PROPER USE	19
5.1 5-Point Harness	19
5.2 Rear View of Car Seat	20
5.3 Rear View of Component Locations	21
5.4 Base.....	22
5.5 Use of the Safety Seat with the Base	24
5.6 Other Features.....	24
5.7 Operation of the Carry Handle	26
5.8 Attaching the Canopy.....	27
5.9 Ergonomic Carry Grip	27
5.10 Insert Use.....	27
5.11 Adjustment of the Shoulder Straps.....	29
5.12 Adjustment of Crotch Buckle Length.....	33

TABLE OF CONTENTS

USING INFANT RESTRAINT	35
6.1 Securing your Child in the Safety Seat / Carrier	35
6.2 For the 5-Point Harness.....	37
SECURING THE SAFETY SEAT OR BASE IN THE VEHICLE	38
7.1 Preparation	39
7.2 Installation of the Safety Seat / Vehicle Belt Installation of Base:	40
7.3 Installation of the Base using LATCH	46
7.4 Setting Proper Recline of the Safety Seat / Base	50
7.5 Elevation Aids	53
7.6 Elevation Aids Base Use.....	54
7.7 Pool Noodle and Towel Examples	53
FINAL SAFETY CHECKS	55
ADDITIONAL INFORMATION	56
9.1 Using the Safety Seat in an Airplane	56
9.2 Using your Baby Trend Safety Seat with a Baby Trend Stroller.....	56
9.3 Cleaning and Maintenance	56
9.4 Replacement Parts	58
WARRANTY	59

WARNINGS TO ALERT YOU TO POSSIBLE DANGERS

The ultimate safety of your child depends on the proper installation of the Safety Seat in your vehicle. Proper installation requires that you read and understand this entire manual and your vehicle's owner's manual before placing your child in the Safety Seat. **DO NOT** allow others to install or use this safety seat unless they completely understand its proper use and installation.

Improper use of this Safety Seat can result in death or serious injury from a crash, sharp turn or sudden stop.

Your child's safety depends on:

- 1. Choosing the best location within your vehicle for the Safety Seat. Seating positions with Active Air Bags must be avoided.**
- 2. Adjust the harness shoulder strap locations to the appropriate height for your child.**
- 3. Adjust the harness length to be snug around your child.**
- 4. This Safety Seat is only to be used in the rear-facing position.**
- 5. Proper use and routing of the seat belts in your vehicle is essential for proper installation. Not all vehicle seat belts will adequately secure the Safety Seat.**
- 6. Proper recline angle of the Safety Seat is required for maximum protection of your child.**

HOW TO REGISTER YOUR SAFETY SEAT

Please complete the following information regarding this Safety Seat:

Model Number : _____

Manufacture Date : _____

Purchase Date : _____

The model number can be found on a label on the side of the Safety Seat. The manufactured date can be found on a label on the bottom of the seat.

Please fill out the prepaid registration post card attached to the safety harness and mail it today. In addition, we may find a need to update this instruction manual from time to time.

Child restraints could be recalled for safety reasons. You must register this restraint to be reached in a recall. Send your name, address, email address if available, and the restraint's model number and manufacturing date to **Baby Trend, Inc, 13048 Valley Blvd. Fontana CA 92335** or call **1-800-328-7363** or register online at <https://babytrend.com/pages/car-seat-product-registration> For recall information, call the **U.S. Government's Vehicle Safety Hotline** at **1-888-327-4236** (TTY: 1-800-424-9153), or go to <http://www.NHTSA.gov>.

SAFETY INFORMATION

3.1 About your child

- This Safety Seat is designed and tested to accommodate a child of a specific range of HEIGHT and WEIGHT. Using the Safety Seat for a child whose weight or height is outside of these limits will increase the risk of death or serious injury in the event of a crash. Please see the Warning label on the Safety Seat located on the child's right side for weight and height limits for your model. Also noted on manual cover.
- Special needs children, such as pre-term babies, may suffer difficulties in using this Safety Seat. The angle of recline in this Safety Seat may not be appropriate for Special Needs babies. If your child has special needs or any breathing difficulties, please discuss vehicle Safety Seats with your pediatrician, or other competent health care provider, to ensure the safety of your child.
- Never leave your child unattended, even for a moment.
- Do Not Dress your child in bulky clothing or other garments that will hinder the harness from being snug around your child and properly latched between your child's legs.

3.2 About your vehicle

- Proper installation of the Safety Seat in your vehicle and proper securing of your child in the Safety Seat are essential to ensure

the safety of your child. Quick turns, sudden stops, or other maneuvers in avoiding a crash, as well as a crash, can injure your child if not properly secured in the seat or if the seat is not properly installed in the vehicle.

- There are many different types of vehicles, seat belt systems, or other occupant restraint systems in use today. Accordingly, this manual can only give guidelines for proper installation in your vehicle. In addition to this manual, **you must also read and understand the vehicle owner's manual**, which should address use of child restraints. If your vehicle owner's manual does not address the installation of child restraints, please contact your local vehicle dealer, or the vehicle's manufacturer, to obtain this information before using this Safety Seat.
- Some vehicles **do not have any safe location** for this Safety Seat to be installed. In addition, **many vehicles do not have seat belt systems that will adequately hold this Safety Seat** in the required position. Please refer to both this manual and your vehicle owner's manual for complete information for proper safe installation of this Safety Seat.
- **Never** combine this Safety Seat or Base with any other Safety Seat or Base from any other manufacturer. If you are in need of an additional Base, please contact your local dealer or Baby Trend, Inc. to obtain one.
- This Safety Seat is certified for use in Motor Vehicles and Aircraft and conforms to all applicable Federal Motor Vehicle Safety Standards.

3.3 About Active Air Bags

NEVER PLACE THIS SAFETY SEAT IN A VEHICLE SEATING LOCATION THAT HAS AN ACTIVE AIR BAG. If an Active Air bag inflates, it can hit the safety seat with great force and cause death or serious injury to your child. Refer to your vehicle owner's manual for additional information and warnings about Active Air bags, and supplemental restraints, and their proper use with Safety Seats.

3.4 About an unoccupied Safety Seat

- **Never leave the Safety Seat or Base unsecured in your vehicle.** An unsecured seat or base can fly through the vehicle in the event of a crash, sudden stop or sharp turn and cause serious injury to the driver, who may then lose control of the vehicle, or to passengers. When not in use, either remove the seat and or base from the vehicle or make sure that both are securely belted to the vehicle according to these instructions.
- The Safety Seat may become **very hot** if left in direct sunlight. Your child may suffer burns from hot plastic components. Always check the seat for hot surfaces that may come into contact with your child before placing your child in the seat. We suggest that you cover the seat with a blanket or towel if it will be subject to direct sunlight while you are away from the vehicle.

3.5 About this Safety Seat

- This Safety Seat is constructed of plastic that can deform over time if left with any object in the seat while stored. **DO NOT** leave heavy objects in the seat while not in use. **DO NOT** store the seat in the trunk of your car with heavy objects on it or with pressure on the seat from the trunk lid.
- **Replace the Safety Seat and Base after an accident of any kind.** An accident, even a minor accident, can cause undetectable damage to the Safety Seat or Base that may cause the Seat or Base to fail in a subsequent accident. **DO NOT use the safety seat if it is damaged or broken.**
- Discontinue use of the Safety Seat and Base after seven (7) years from the date of manufacture. The date of manufacture can be found on the label located on the underside of the Safety Seat or Base. When discarding an out of date seat, please ensure that someone finding the seat will be unable to use it. We suggest that you disable the seat by removing the pad and harness and discarding the pieces at different times.

3.6 About use as a carrier

Never Leave Your Child Unattended, even if they are asleep. Very often when you arrive at your destination you will find that your child has fallen asleep in the Seat. Do not leave the child unattended, even for a minute. Your child can tip or move the carrier by their movements, kicking or grabbing on to their surroundings. If the carrier tips over, your child can suffocate

from the surface that the seat is on as well as from the pressure on their chest from the safety harness. In addition, if the carrier is placed too upright, the child's head can fall forward and cause the child to have difficulty breathing. To avoid death or serious injury from suffocation, falls and other hazards:

- Always place the carrier on a **firm and level surface**. Never place the carrier on soft or plush surfaces such as a bed, comforter, couch, sofa, chair, etc. **The carrier has a very high possibility of tipping over if placed on a soft or plush surface.**
- Fall hazard: Child's movements can slide carrier. Never place the carrier near the edge of high surfaces such as tables, counter tops, shelves, or other elevated surfaces. To prevent falls, stay within arm's reach whenever the carrier is not on the floor or ground.
- Child can strangle in loose safety harness straps. Never leave child in carrier when straps are loose or undone. Always use the safety harness as instructed in this manual when the child is in the carrier.
- Before lifting the carrier with the handle, check that the **handle is firmly locked into position**. The carrier will pivot about an unlocked handle and can result in injury to your child.
- Strings and cords can cause strangulation:
 - **DO NOT** place items with string around a child's neck, such as hood strings, pacifier cords, etc.

- **DO NOT** suspend strings on or over carrier.
- **DO NOT** attach strings to toys.
- **DO NOT** place the carrier near a window where cords from blinds or drapes can strangle a child.

! WARNING

- Never leave child unattended.
- **SUFFOCATION HAZARD:** Infant carrier can roll over on soft surfaces and suffocate child, **NEVER** place carrier on beds, sofas, or other soft surfaces.
- **STRANGULATION HAZARD:**
 - Child can strangle in loose restraint straps. Never leave child in carrier when straps are loose or undone.
 - Children have **STRANGLED** in loose or partially buckled harness straps. Fully restrain the child even when carrier is used outside the vehicle.
- **FALL HAZARD:** Child's activity can move carrier. Never place carrier on counter tops, tables, or other elevated surface. The carrier can fall from the shopping cart. Do not use on shopping cart.

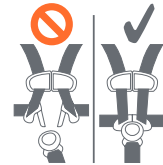

SELECTING THE BEST LOCATION FOR THE SAFETY SEAT

⚠ WARNING

Not every location within an automobile may be safe for the installation of this Safety Seat. In fact, some automobiles have no seating position that is safe for the installation of a safety seat. Improper placement of this Safety Seat within a vehicle will increase the risk of death or serious injury.

Please follow the instructions in this manual and in your vehicle owner's manual carefully to ensure proper location and installation of this Safety Seat. If you are uncertain about the proper location of the Safety Seat within the vehicle, contact your vehicle manufacturer directly, or through their dealer before using this seat. You are also invited to call Baby Trend at 1-800-328-7363 for additional information or assistance.

4.1 Overall Considerations in Selecting a Location

- The rear seating positions have been shown to be statistically safer for children than the front seating position.
- We recommend that you use the center rear seat position as the safest location for the Safety Seat. In addition, whenever possible, have an adult ride in the rear with the child in order to monitor the child.

- If the driver is the only adult in the vehicle and the child requires constant monitoring, then the forward seating position may be used if there is no passenger side Active Air bag and all of the following requirements are met for this location.

4.2 Check that the Vehicle Seat Meets the Following Requirements

⚠ WARNING



DO NOT place rear-facing child seat on front seat with air bag. **DEATH OR SERIOUS INJURY** can occur. The back seat is the safest place for children 12 and under.

- **Never** place this Safety Seat in a vehicle seating location that has an Active Air Bag! Active Air Bags inflate with great force! An inflating active Air Bag can strike a Safety Seat with enough force to cause death or serious injury to your child. If your vehicle is equipped with a front passenger side Active Air bag, please refer to the vehicle's owner's manual for additional information about Active Air bags and child safety seat installation.

- **DO NOT** place this Safety Seat in any vehicle seat that faces to the rear or to either side of the vehicle (Fig. 14-1 & 14-2).
- **DO NOT** use this Safety Seat in a vehicle that has a vehicle seat back that does not lock into place. A seat back that folds forward must have a latch or locking mechanism to prevent it from flying forward and striking the child in a sudden stop or accident.
- Please review your vehicle owner's manual to determine the best location for the Safety Seat or to determine if any locations are unsafe for safety seat installation. If you do not have the vehicle owner's manual or the owner's manual does not address child safety seat installation, please contact the vehicle manufacturer to obtain this information before using the safety seat.



Fig. 14-1



Fig. 14-2

4.3 Check that the Vehicle Seat Belt is Safe to Use

The Safety Seat is designed to be tightly installed at all times. The vehicle seat belt must be capable of maintaining tight installation at all times. A variety of vehicle seat belt systems have been installed on vehicles that are not safe for

use with the Safety Seat. Even newer vehicles can have seat belts systems that are not safe for use with the Safety Seat. These systems may look safe but their method of operation precludes their use with the Safety Seat. If you are unsure if the vehicle seat belt is safe for use with the Safety Seat, please contact the vehicle manufacturer for additional information.

⚠ WARNING

Carefully analyze the operation of the vehicle safety belts before using the Safety Seat. Being able to thread the vehicle seat belt through the Safety Seat or Base is not an indication that the vehicle seat belt is safe to use. Carefully read this section on seat belt systems, review your vehicle owner's manual in detail, and heed any and all warning labels on your vehicle's seat belt. Your vehicle may require a modification or special seat belt in order to be safely used with this Safety Seat. Please see your vehicle dealer for this service.

Seat belt systems that are NOT safe for use with the Safety Seat:

DO NOT use the following types of seat belt systems with the Safety Seat. These belt systems will not hold the Safety Seat securely in place at all times. In addition, a locking clip will not make these belt systems safe to use.

4.0 LOCATION

- **DO NOT** use a lap belt that stays loose after installed and locks only in a crash or sudden stop. These lap belts utilize an Emergency Locking Retractor and are often found in combination with motorized shoulder belts. Because these belts will allow the Safety Seat to move about on the seat, the chance of the Safety Seat being out of the proper position in a crash is very high. Accordingly, do not use the Safety Seat with this type of Seat Belt system. Please see your vehicle's dealer or owner's manual for information on converting this seat belt system to one that is acceptable for use with a Safety Seat (Fig. 15-1).



Fig. 15-1

- **DO NOT** use a lap/shoulder belt system if the lap belt and shoulder belt each have retractors at one end. This type of seat belt system will not adequately restrain the Safety Seat (Fig. 15-2).



Fig. 15-2

- **DO NOT** use a seat belt that is connected to the door in any way. These types of seat belts are designed to automatically surround the occupant when the door is closed. This type of seat belt will NOT adequately restrain the Safety Seat. (Fig. 15-3).

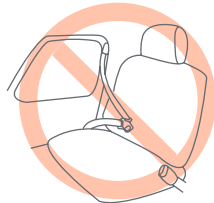

Fig. 15-3

4.0 LOCATION

- **DO NOT** use a seat belt that is anchored on the seat more than 2 inches forward of the crease between the seat bottom and the seat back. This type of seat belt anchors the Safety Seat too far forward and the Safety Seat will not be safely restrained in the vehicle (Fig. 16-1).
- **DO NOT** use a shoulder belt that moves along a track. These systems typically move to surround the occupant when the door is closed. This type of belt system will **NOT** adequately restrain the Safety Seat (Fig. 16-2).



Fig. 16-1

If you have any of the above seat belt systems, **DO NOT** use it to secure the Safety Seat in the vehicle. Look in the vehicle for a location that has a more suitable seat belt system as described in the section following. You may also contact your vehicle's manufacturer to inquire about installing a seat belt system that is adequate to restrain a Safety Seat.

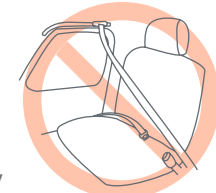

Fig. 16-2

Seat belt systems that are Adequate for use with the Safety Seat:

The following seat belt systems can be used with the Safety Seat provided, that all of the other requirements prescribed in these instructions, including seat position, and all instructions provided by your vehicle's owner's manual are followed.

- A lap belt that is manually adjusted and will remain tight while the vehicle is in motion is suitable for use with the Safety Seat. Pulling the belt through the buckle after the buckle is fastened tightens this type of seat belt. The center rear seat belt is most often this type of seat belt (Fig. 17-1).



Fig. 17-1

- A lap belt that cannot be lengthened once it is fastened is suitable for use with the Safety Seat. These seat belts often have an automatic locking retractor that will allow the belt to be lengthened but once fastened, must be unbuckled and allowed to retract fully before allowing the belt to be lengthened again (Fig. 17-2).



Fig. 17-2

- A lap/shoulder combination seat belt with a latch plate that locks the lap belt into position is suitable for use with the Safety Seat. Once this type of seat belt is fastened, the latch plate prevents the lap belt from loosening.

This combination seat belt does not require a locking clip (Fig. 18-1).



Fig. 18-1

- A lap/shoulder combination belt system with a latch plate that can slide freely along the belt is suitable for use with the Safety Seat if it includes a lockable retractor or if a locking clip is used to secure the lap belt into position and prevent loosening. Use the locking clip provided with the Safety Seat as instructed on page 41. **Please refer to your vehicle's owner's manual for additional information on locking this style of seat belt.** This style of belt must be locked to prevent movement of the Safety Seat (Fig. 18-2 & 18-3).

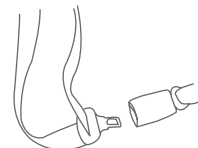

Fig. 18-2

Some on-base locking clip applications based on the automobile buckle stalk length may necessitate the locking clip is placed in the center of the base belt path. (Fig. 18-4)

Contact Baby Trend at 1-800-328-7363 to obtain a Locking Clip.

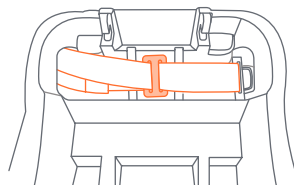

Fig. 18-4

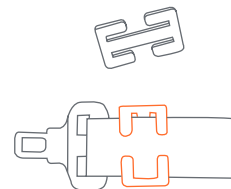
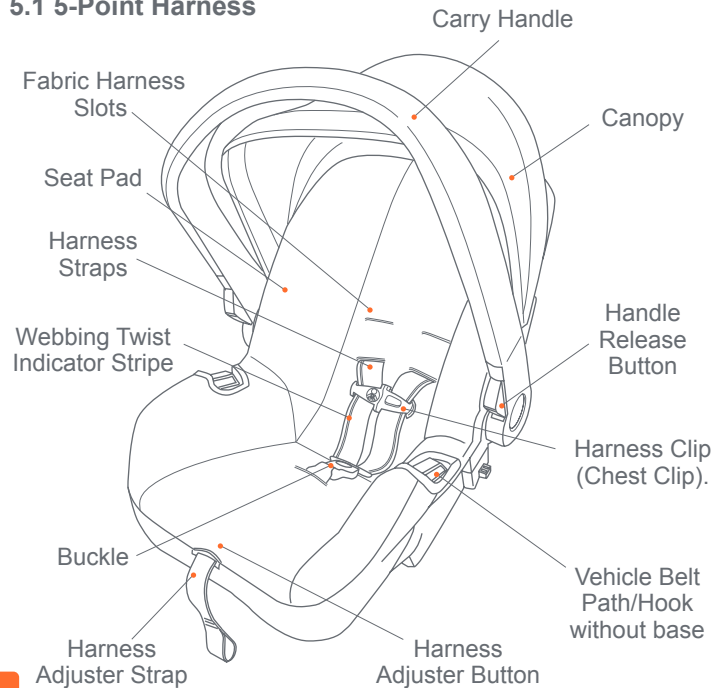

Fig. 18-3

SAFETY SEAT FEATURES AND THEIR PROPER USE

5.1 5-Point Harness



5.2 Rear view of Car Seat

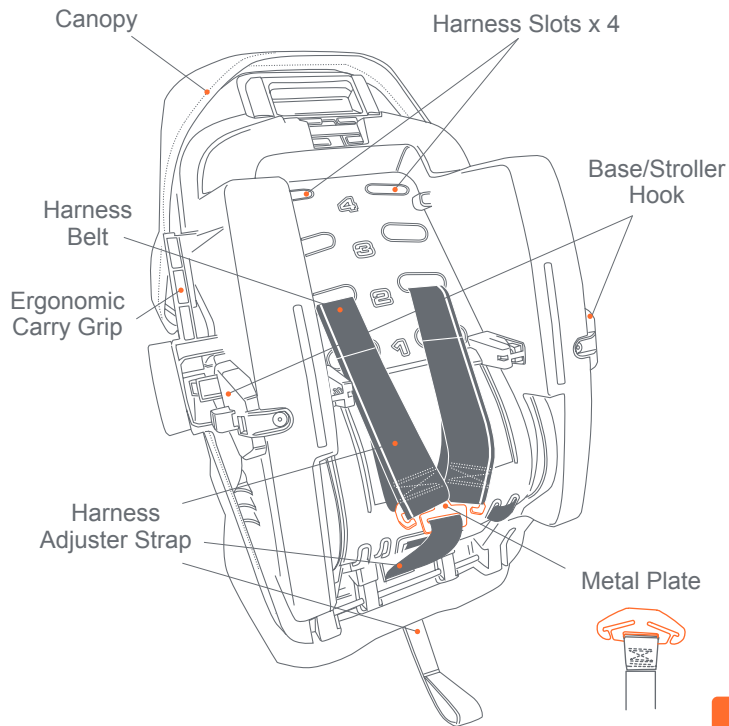

5.3 Rear view of Component locations

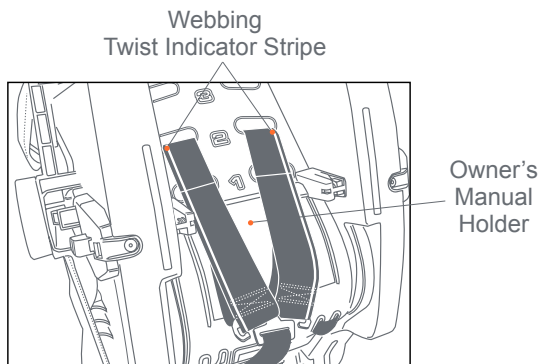
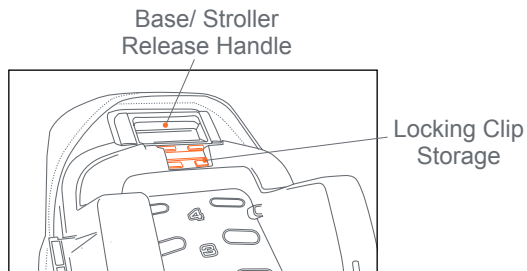

5.4 Base

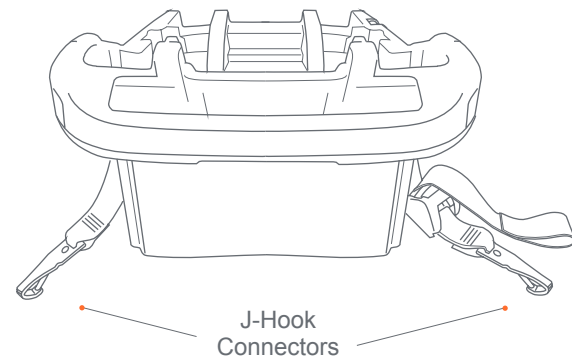
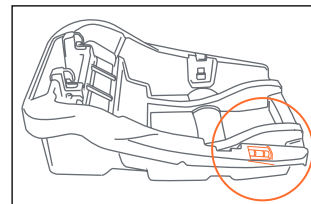
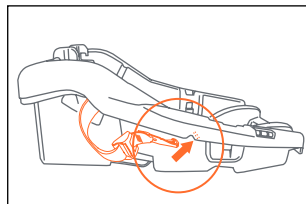

Your Safety Seat base can be installed with either the vehicle belt or with the included LATCH attachment system.

To properly install the Safety Seat and protect your child, you must carefully follow the instructions that correspond with the model you have purchased.

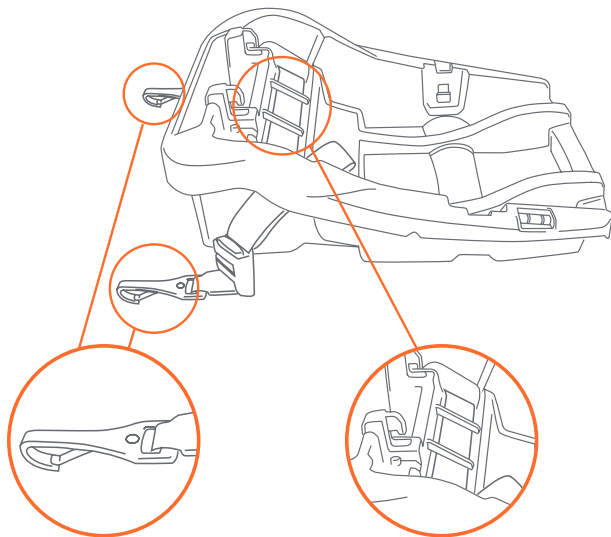

J-Hook Connectors

Vehicle Belt Path

5.5 Use of the Safety Seat with the Base

- To remove the car seat from the base, squeeze the Base Release handle, located below the head end of the Safety Seat, to release the Safety Seat from the Base. Refer to (Fig. 24-1).
- To attach the Safety Seat to the Base, align the Safety seat with the Base and push down until the Safety Seat latches onto the Base. Check that both sides of the Safety Seat are securely attached to the base.

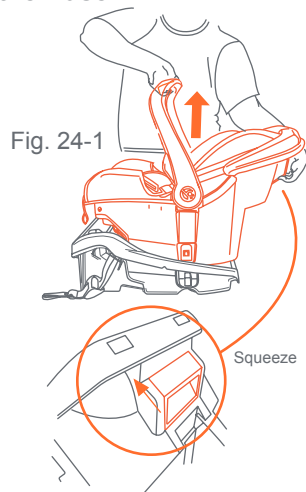
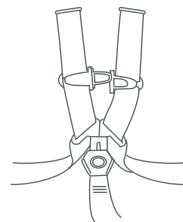

Fig. 24-1

5.6 Other Features

Harness

We manufacturer several different styles of Safety Seat each with various levels of features, adjustments, and weight and size ratings. Please follow the instructions that correspond with the features included on your particular model.



5-Point Harness

Seat Angle Indicators

The Seat Angle Indicator is used to ensure that the seat is installed at the proper degree of recline to adequately protect your child in a crash.

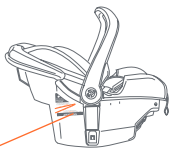
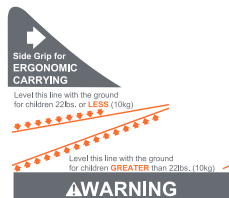
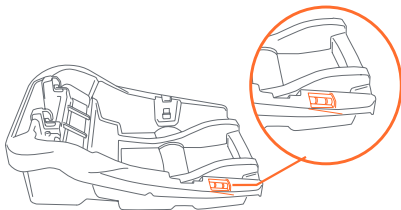

Locking Clip

The Locking Clip is stored at the head end of the Safety Seat and is used to securely install the Safety Seat with certain types of vehicle lap/shoulder combination belts. Contact Baby Trend at 1-800-328-7363 to obtain a Locking Clip.

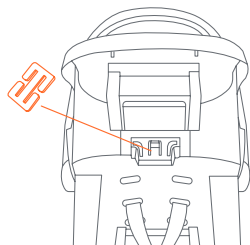

Locking Clip

5.7 Operation of the Carry Handle

⚠ WARNING

Toys or other objects attached to carry handle can cause injury in a crash. Never attach toys or other objects to handle when in vehicle.

The Carry Handle has five positions: Rebound, the carry position, a mid-storage position, a storage position and the non-rocking position.



Rebound



Carry

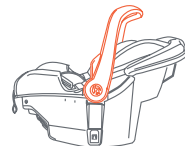

Storage



Mid-Storage

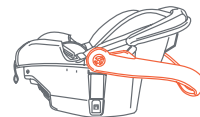

Non-Rocking

In-Vehicle Handle Use

ONLY use **Rebound** or **Carry** Handle positions in vehicle. Use **Carry position** for children greater than 22 lb or if feet can touch the handle (Fig. 27-1).

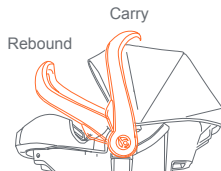

Fig. 27-1

To adjust handle position

- Depress the two buttons located on the handle just above the connection to the Car Seat shell to release the handle.
- Slowly rotate the handle to the desired position. The buttons should pop out and the handle should automatically lock into the new position (Fig. 27-2).
- Before lifting the Car Seat, push on the handle to check that both sides of the handle have locked into the Carry position.

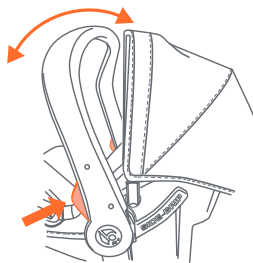
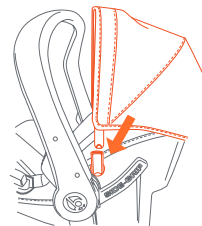

Fig. 27-2

5.8 Attaching the Canopy

Slip the canopy stays through the sleeves on the canopy.

The canopy is attached by inserting the ends of the canopy plastic stays into the female fittings found on the inside of the handle hub.



Use the hook and loop fasteners on the rear side of the fabric to join the canopy to the Car Seat frame.

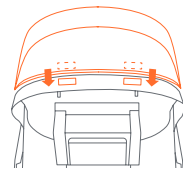

5.9 Ergonomic Carry Grip

- Rotate handle to the carry position. Cross forearm through the carry handle to place your hand on the grip.

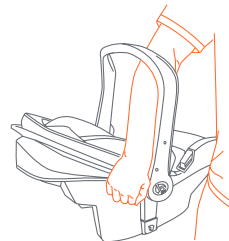

5.10 Inserts Use

- Use is not mandatory
- **ONLY** use inserts with children who weigh between 4-18 lbs.
- **DO NOT** use Pillow insert use if child's head is pushed forward and falls down.
- **NOT** included in all models, styles may vary.

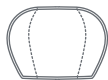

Pillow Insert



Body Insert

5.11 Adjustment of the Shoulder Straps

⚠️ WARNING

Failure to properly adjust the harness on your child increases the risk of death or serious injury in the event of a sharp turn, sudden stop or crash. Please follow the instructions very closely to ensure that the harness is properly adjusted to fit your child at all times. Your child will grow very rapidly! Please check the fit of the harness every time you use the Safety Seat.

Safety Seat

This Safety Seat features four height adjustments for the harness shoulder straps.

The harness straps must be used in the slots that position the straps to be even with or just below your child's shoulders (Fig. 28-1). The harness straps are adjusted as follows:

1. Remove the Safety Seat from the Base and rotate the Carry Handle to the back position. Place your child in the Safety Seat such that your child's bottom is all the way to the rear and bottom of the seat.
2. Determine which pair of slots will position the harness straps even with or just below your child's shoulders. **DO NOT** use harness slots that will position the harness straps above your child's shoulders as the harness straps in this position will not restrain a small child in a sharp turn, sudden stop or crash.

Proper height is even or just below shoulder

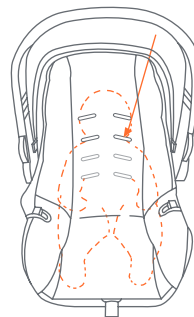

Fig. 30-1

3. If the Harness Straps require adjustment, remove your child from the Safety Seat. Rotate the handle to the upright carry position (Fig. 31-1).
4. Loosen the harness straps by depressing the Harness Adjuster Button located below the flap just ahead of the Harness Buckle and pulling on the harness straps.
5. Turn the seat over. Locate the Belt Adjuster Plate near the bottom of the seat (Fig. 31-2). Remove both Harness Straps from the Belt Adjuster Plate. From the front of the seat, pull the Harness Straps through the shoulder area slots and seat pad.



Fig. 31-1

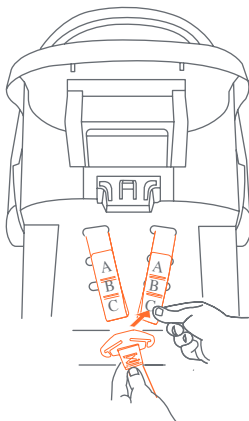

Fig. 31-2

6. Using the included Belt Threading Tool, insert the Harness Straps through the Slots selected in step 2 above, in the seat pad and the seat shell, respectively (Fig. 32-1).
7. From the rear of the Safety Seat, pull the Harness Straps through the Slots until you have enough strap to reach the Belt Adjuster Plate.
8. Reassemble the Harness Straps to the Belt Adjuster Plate. Do the left Harness Strap first, followed by the right Harness Strap. Check that Harness Straps are completely within the Belt Adjuster Plate loop (Fig. 32-2). You have three adjustment positions on the harness.

Belt Threading Tool

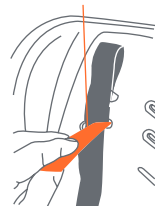

Fig. 32-1

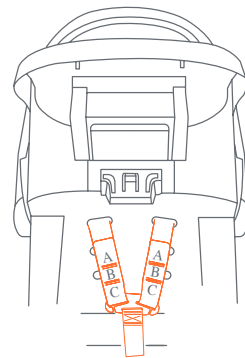

Fig. 32-2

9. Ensure the harness strap ends are fully hooked on the metal plate. Both sides must be threaded in the same position (Fig. 33-1).
10. Inspect the Harness Straps from the front and rear to ensure that they are not twisted. Twisted straps can prevent proper tightening of the Harness and thus may not adequately restrain your child in a sharp turn, sudden stop or crash.
11. Before using the Safety Seat, please pull on the Harness Straps from the front to ensure that they are securely reattached.
12. Fold webbing over metal plate and secure with hook and loop fastener (Fig 33-2).

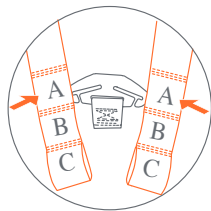

Fig. 33-1

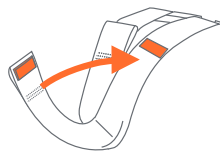

Fig. 33-2

5.12 Adjustment of the Crotch Strap Length

The crotch strap is adjustable in length to ensure a safe and comfortable fit for harness. The crotch strap length should be adjusted such that a gap of 1/2" to 1" is present between the ears of the buckle, and the top of the child's thigh, disregarding any clothing or diaper (Fig. 34-1). Your child will grow very quickly so always check that the buckle is the proper height whenever placing your child in the Safety Seat.

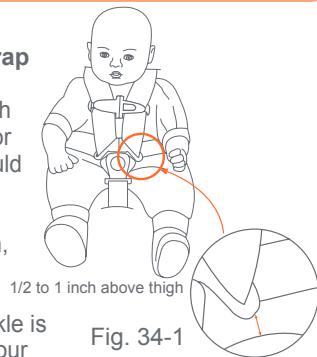

Fig. 34-1

The crotch strap length adjustments: To **shorten** buckle webbing length, thread the anchor bracket through the slot closest to the in-use position. Ensure the Anchor Bracket is completely through. To **lengthen** buckle webbing, undo the anchor bracket from the second slot and pull the buckle up. Ensure the Anchor Bracket secures in place (Fig. 34-2).

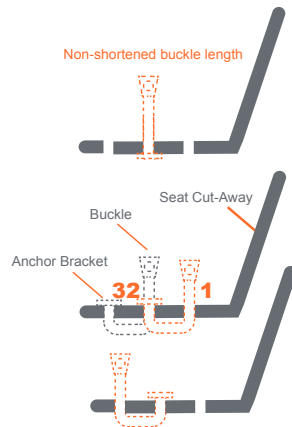
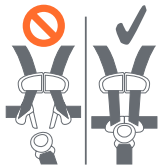

Fig. 34-2

USING INFANT RESTRAINT

6.1 Securing your Child in the Safety Seat / Carrier

! WARNING



Children have **STRANGLED** in loose or partially buckled harness straps. Fully restrain the child even when carrier is used outside the vehicle.

Failure to properly secure your child in the Safety Seat / Carrier increases the risk of death or serious injury from suffocation or falls, or in the event of a sharp turn, sudden stop or crash.

In a crash, the safety seat provides no protection for your child unless the Harness Straps are properly installed according to these instructions. Make sure that the harness straps are properly adjusted and secured whenever using the Safety Seat, even when using as a carrier.

Please follow these instructions carefully to properly secure your child.

1. Check that the Harness Straps are installed in the proper slots or adjusted to the proper height as described in section 5.9, **Adjustment of the Shoulder Straps**, preceding.

2. The clothing you dress your child in will affect the proper use of the Safety Seat. Please dress your child in clothing that will:
 - Allow the Harness Straps to securely latch between your child's legs.
 - Keep the shoulder straps properly located on your child's shoulders.

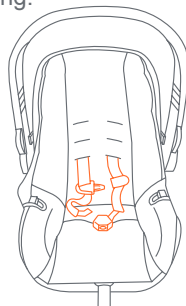

Fig. 36-1

3. Place the Safety Seat on a firm and level surface. Move the carry handle to the non rocking position. Loosen the Harness Straps by pulling on the straps while pushing on the Harness Adjuster Button located below the pad just in front of the buckle. Unfasten the Harness Chest Clip. Unbuckle the Harness Straps and drape the Harness Straps over the Seat back or to the sides of the Safety Seat (Fig. 36-1).



Correct

4. Place your child in the Safety Seat so that the child's bottom is against the back and bottom of the seat (Fig. 36-2).



Incorrect

5. Pull the harness straps down over your child. Check that the harness straps are not twisted.

Fig. 36-2

6.2 For the 5-Point Harness

- Put the two buckle tongues together, overlaying the left buckle tongue onto the right buckle tongue, and insert the two joined buckle tongues into the harness buckle on the crotch strap (Fig. 37-1). Fasten the Harness Chest Clips together. Position the Harness Chest Clip, by sliding the Clip either up or down on the Harness Straps, so that it is level with the child's armpits (Fig. 37-2). Make sure that you hear the tongues click into the buckle and check that both are firmly latched by pulling upward on the straps. If the harness straps are not securely buckled, the safety seat will **NOT** provide protection for your child. **DO NOT** use the safety seat, even as a carrier, if the harness does not securely buckle. Please call Baby Trend at 1-800-328-7363 for assistance.



Fig. 37-1



Fig. 37-2

- From the front of the Safety Seat, pull outward on the Harness Adjuster Strap to tighten the Harness Straps. Make sure that both Harness Straps are flat and snug on your child's shoulders. A snug strap should not allow any slack. It lies in a relatively straight line without sagging. It does not press on the child's flesh or push the child's body into an unnatural position.
- Fasten the Harness Chest Clips together. Position the Harness Chest Clip, by sliding the Clip either up or down on the Harness Straps, so that it is level with the child's armpits.

Accessory products for use with the Safety Seat are acceptable for use provided that they do not interfere with the harness assembly, or the proper adjustment of the harness such that it remains tight on the child's shoulders at all times.

Thick, soft, or other compressible material in excess of 1/4 inch thick should not be placed behind or under the child or between the child and harness straps. Examples of accessory products are head support pillows or rolled blankets to add additional head support.

!WARNING: Toys or other objects attached to carry handle can cause injury in a crash. Never attach toys or other objects to handle when in vehicle.

SECURING THE SAFETY SEAT OR BASE IN THE VEHICLE

Please read carefully section 4.3, **Check that the Vehicle Seat Belt is Safe to Use**, before proceeding with the installation of the Safety Seat. Please understand that due to the extremely large number of vehicles in use today, and the correspondingly large number of safety belt systems, this section can only provide guidance, as to the proper installation of the Safety Seat, that must be combined with the information provided by your vehicle manufacturer in order to obtain a proper and safe installation.

!WARNING

Failure to properly install and secure the Safety Seat in a rear facing position within the vehicle increases the child's risk of death or serious injury in the event of a sharp turn, sudden stop or crash. Carefully follow these instructions, and the instructions provided by your vehicle manufacturer for the installation of child safety seats, to ensure that the Safety Seat is properly located, positioned and held tightly installed at all times.

7.1 Preparation

1. Park your vehicle on a level surface so that the level indicator located on the left side of the Safety Seat will properly indicate the proper angle of recline of the seat.
2. Make sure you have selected an acceptable location for the safety seat as instructed in section **Selecting the Best Location for the Safety Seat** on page 11.
3. Check again for any Active Air bags. **DO NOT** use any location that has an active air bag or is adjacent to an Active Air bag such that, when deployed, the Active Air bag may come into contact with the Safety Seat. Many passenger side Active Air bags are designed to deploy to protect the passenger side as well as the center front seating position. Please see the Active Air bag warnings in your vehicle owner's manual to help determine unsafe locations in the vehicle.
4. If the front seat position is used, slide the vehicle seat as far to the rear as possible to prevent the safety seat from striking the dash in a crash. If the rear seat position is used, slide the vehicle seat directly in front of the Safety Seat forward enough to prevent the Safety Seat from striking the vehicle seat back in a crash.
5. Check that the vehicle seat back is locked in the upright position and will not fold forward onto the Safety Seat. (Fig. 40-1).

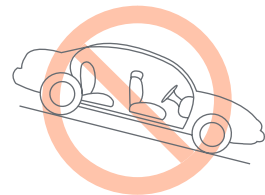
7.2 Installation of the Safety Seat / Vehicle
Belt Installation of Base:

!WARNING: Toys or other objects attached to carry handle can cause injury in a crash. Never attach toys or other objects to handle when in vehicle.

1. Remove any toy or other objects attached to carry handle before installing car seat in vehicle.
2. Remove the Safety Seat from the base by squeezing the base release handle located under the center of the head end of the Safety Seat and lifting upward on the Safety Seat (See Fig. 24-1). **Store both LATCH connectors as shown in Fig. 45-1.**
3. If you are using the Base with the Safety Seat, place the Base in the rear-facing position in a forward facing vehicle seat as shown in Fig. 40-2. If you are using the Safety Seat without the Base, place the Safety Seat in a rear-facing position in a forward facing vehicle seat as shown in Fig. 41-1. **The Child must face the rear of the vehicle and Safety Seat must be placed in a vehicle seat that faces forward.**

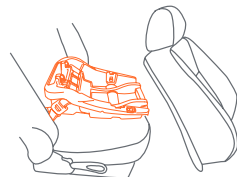

Folding seat must be locked

Fig. 40-1

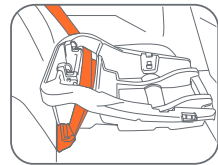

Lap/Shoulder Belt

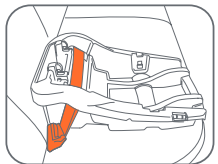

Lap Belt only

Fig. 40-2

7.0 INSTALLATION

- See Fig. 40-2 for the proper threading of the vehicle belt through the Base and Fig. 41-1 for the proper threading of the belt through the Safety Seat without the Base.
- Buckle the seat belt being careful that the seat belt is not twisted and is securely latched into the appropriate buckle, and not the adjacent buckle (Fig. 41-2).
- Proper installation of the Safety Seat or Base requires that the seat belt be very tight. To tighten the seat belt, push down hard with your knee or hand on the Safety Seat or Base while pulling and tightening the seat belt. **Check that there is no slack in the seat belt on either side of the Safety Seat or Base, or anywhere along the path of the belt, and that the seat belt is tight from end to end.** (Fig. 41-3 and 41-4).

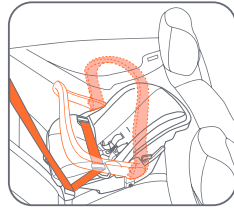

Lap/Shoulder Belt

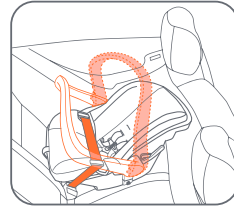

Lap Belt only
Fig. 41-1

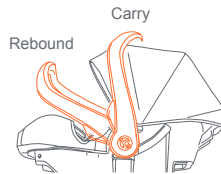

Fig. 41-3

ONLY use Rebound or Carry Handle positions in-vehicle. Use Carry position for children greater than 22 lb. or if feet can touch the handle (Fig.41-3).

7.0 INSTALLATION

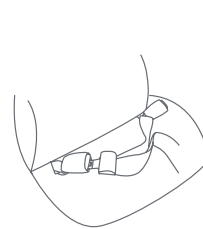

Fig. 41-2

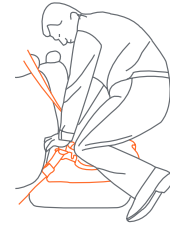

Fig. 41-3

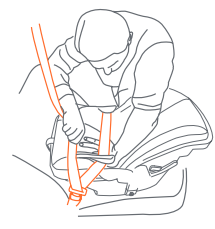

Fig. 41-4

- To tighten a lap belt only:

- An **automatically retracted** lap seat belt is tightened by feeding belt back into its retractor while pushing down hard on the Safety Seat or Base. Make sure that the retractor locks the lap belt into place and that the belt remains very tight (Fig. 42-1).



Fig. 42-1

- A **manually adjusted** lap seat belt is tightened by pulling on the free end of the seat belt while pushing down hard on the Safety Seat or Base. If you experience difficulty tightening the seat belt, unbuckle the seat belt, tighten the seat belt a small amount and re-buckle the seat belt. Repeat this procedure until the seat belt is very tight around the Safety Seat or base. Check that the seat belt remains very tight around the Safety Seat or base (Fig. 42-2).

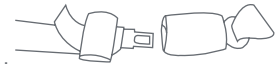

Fig. 42-2

8. To tighten a combination **lap/shoulder seat belt**:

- A lap/shoulder combination belt with a locking buckle is tightened by pulling upward on the shoulder portion of the seat belt while pushing down hard on the Safety Seat or Base. If you experience difficulty tightening the seat belt, unbuckle the seat belt, tighten the seat belt a small amount and re-buckle the seat belt. Repeat this procedure until the seat belt is very tight around the Safety Seat (Fig. 43-1).



Fig. 43-1

9. A lap/shoulder combination seat belt with **a buckle that can slide freely** along the seat belt may require the use of a locking clip (Fig. 43-2). Check your vehicle's owner's manual to see if the vehicle manufacturer has provided an alternate manner, such as a locking retractor in which to prevent movement of the lap portion of the seat belt.

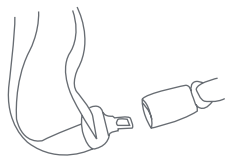

Fig. 43-2

- To install the locking clip, tighten the buckled seat belt by pulling upward on the shoulder portion of the seat belt while pushing down hard on the Safety Seat or Base.
- While maintaining downward pressure on the Safety Seat or Base, squeeze the shoulder belt and lap belt together just above the buckle to prevent from moving. Unbuckle the seat belt being careful to prevent movement of the buckle.
- Secure the shoulder belt to the lap belt by installing the locking clip 1/2 inch from the buckle as shown in (Fig. 44-1).

Some on-base locking clip applications based on the automobile buckle stalk length may necessitate the locking clip is placed in the center of the base belt path (Fig. 44-2).

- Re-buckle the seat belt and check that the seat belt is very tight around the Safety Seat or Base. Pull on the lap belt to ensure that the locking clip is locking the lap belt and it remains very tight.

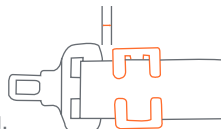

Fig. 44-1

Contact Baby Trend at 1-800-328-7363 to obtain a Locking Clip.

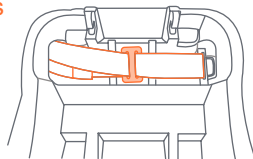

Fig. 44-2

10. If you are using the Base, check that nothing is on top of the base, or anything that will interfere with the proper latching of the Safety Seat to the Base. Place the Safety Seat onto the Base and push down until the Safety Seat latches securely to the Base and you hear a click (Fig. 45-1). Pull upward on the Safety Seat to check that the Safety Seat is securely latched onto the base (Fig. 45-2).

If the Safety Seat does not securely latch onto the Base, the Safety Seat will **NOT** provide Protection for your child. **DO NOT** use the Safety Seat with the Base if it does not securely latch into place. Please call Baby Trend at 1-800-328-7363 for assistance.

11. Adjust carry handle into the rebound position for children that weigh 22 lb (10 kg) or less or adjust carry handle to Carry position for children that weigh greater than 22 lb or feet can touch the handle adjustment (Fig. 45-2).

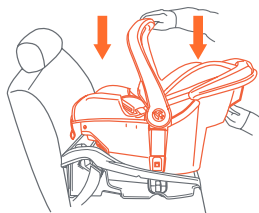

Fig. 45-1

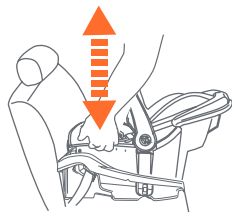

Fig. 45-2

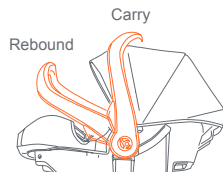

Fig. 45-2

7.3 Installation of the Base using LATCH



Lower Anchors and Tethers for Children (**LATCH**). System is designed to make installation of child safety seats easier by requiring child safety seats to be installed without using the vehicle's seat belt system. By September 1, 2002, two rear seating positions of all cars, mini vans and light trucks will come equipped with lower child safety seat anchor points located between a vehicle's seat cushion and seat back. Also by September 1, 2002, all child safety seats will have two attachments which will connect to the vehicle's lower anchor points. Together, the lower anchors and upper tethers make up the **LATCH** system. Rear-facing infant seats do not make use of the upper tether.

7.0 INSTALLATION

1. Remove any toy or other objects attached to carry handle before installing car seat in vehicle.
2. Locate a **LATCH** seating position as identified in your vehicle owner's manual. Some **LATCH** seating positions may require deploying of anchors, or installation of guides.

3. Remove the Safety Seat from the base by squeezing the base release handle located under the center of the head end of the Safety Seat and lifting upward on the Safety Seat (Fig. 24-1).

4. Remove the **LATCH** connectors from their storage position inside the base (Fig. 47-1). Place the Base in the rear-facing position in a forward facing vehicle seat as shown in Fig. 47-2. **The Child must face the rear of the vehicle and Safety Seat must be placed in a vehicle seat that faces forward.**

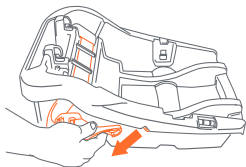

J-Hook Storage

Fig. 47-1

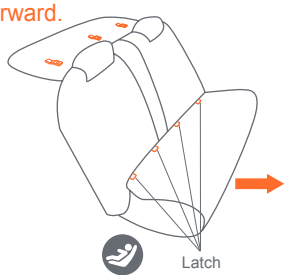

Latch

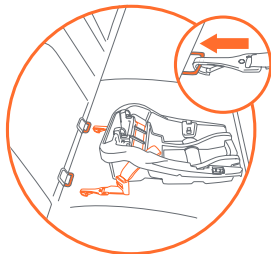
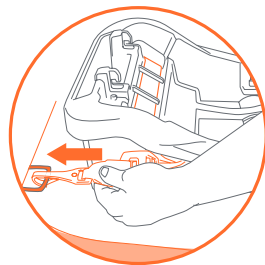
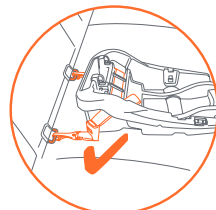

Fig. 47-2

5. Locate the **LATCH** anchors in the vehicle seat (Fig. 47-2). Once located, snap the Safety Seat **LATCH** connectors onto the steel rod. Listen for the click and check that both connectors are firmly attached to the anchor rods by pulling outward on the connectors (Fig. 48-1).



6. Proper installation of the Base requires that the **LATCH** webbing be very tight. To tighten the webbing, push down hard with your knee or hand on the Base while pulling upward on each webbing end. The webbing will automatically lock in place. **Check that there is no slack in the webbing on both sides of the base and that the base is tightly installed (Fig. 48-2 and 48-3).**



Snap onto anchors

Fig. 48-1

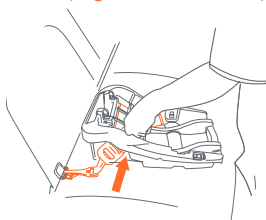

Fig. 48-2

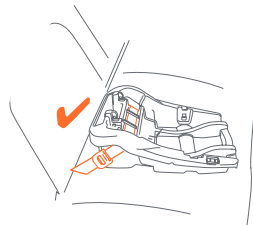

Fig. 48-3

7. Check that nothing is on top of the base or anything that will interfere with the proper latching of the Safety Seat to the Base. Place the Safety Seat onto the Base and push down until the Safety Seat latches securely to the Base and you hear a click. Pull upward on the Safety Seat to check that the Safety Seat is securely latched onto the base (Fig. 24-1).

If the Safety Seat does not securely latch onto the Base, the Safety Seat will provide No Protection for your child. **DO NOT** use the Safety Seat with the Base if it does not securely latch onto the Base. Please call Baby Trend at 1-800-328-7363 for assistance.

8. To remove the base from the vehicle, squeeze the webbing release button on the **LATCH** connector to loosen the webbing (Fig. 49-1a).

NOTE: The **LATCH** connector can not be released from the **LATCH** anchor if the webbing is tight. Press the **LATCH** hook release button on each connector to release the connector from the anchor (Fig. 49-1b).

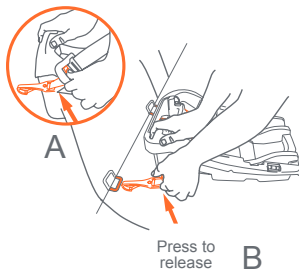
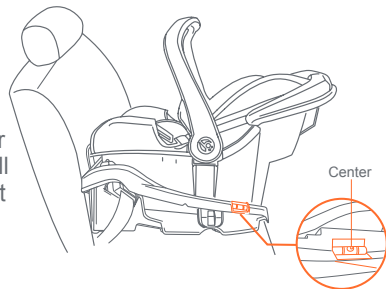

Fig. 49-1

7.4 Setting Proper Recline of the Safety Seat / Base

For your child's safety, the Safety Seat must be properly reclined when installed in the vehicle. The Safety Seat includes a Seat Angle Indicator on the lower portion of the shell on the child's left side, to assist in achieving the proper angle of recline for the Safety Seat (Fig. 50-1).



Use weight range as appropriate
See warning label on safety seat

Fig. 50-1

⚠️ WARNING

Failure to properly recline the Safety Seat on the vehicle seat increases the risk of death or serious injury. If the Safety Seat is positioned too upright, the child's head may drop forward and result in breathing problems. If the Safety Seat is too reclined, excessive force may be exerted on the child's shoulders and neck in a crash. The following instructions must be carefully followed to ensure proper recline angle for the Safety Seat.

1. Safety Seat with Base: Make sure the vehicle is parked on level ground. Lock the Safety Seat onto the Base and check that the Safety Seat is level side to side on the vehicle seat (Fig. 51-1). Check the Seat Angle Indicator that matches the weight of your child.

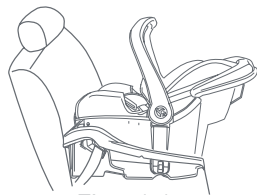

Fig. 51-1

- If the Seat Angle Indicator shows the bubble centered between the lines, the seat is installed at the proper level of recline for occupants 4-22 lb. (Fig 51-2).

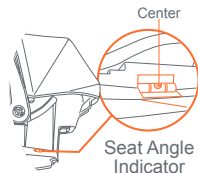

Fig. 51-2

- If the Seat Angle Indicator shows the level line parallel with the ground, the seat is installed at the proper level of recline for occupants greater than 22 lb. to 30 lb. (Fig 52-3).



Fig. 51-3

- If the Seat Angle Indicator level line is not parallel with the ground, place a rolled towel, or pool noodle, under the front of the base at the foot end to achieve the correct position (Fig. 51-4). See section **7.5 Elevation Aids**. Re-tighten the vehicle seat belt as instructed in section, securing the Safety Seat or Base in the Vehicle.

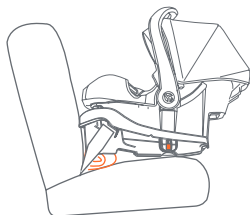

Fig. 51-4

2. Safety Seat without Base: Check that the Safety Seat is level side to side on the vehicle seat. Check the Seat Angle Indicator that matches the weight of your child (Fig. 52-1).



Fig. 52-1

- If the Seat Angle Indicator line is not level, the Safety Seat is either **too upright** or **too reclined**. If the Safety Seat is too reclined adjust the Safety Seat as shown in (Fig. 52-2), until the level indicator shows **level**. If the Safety Seat is too upright, place a tightly rolled towel, or pool noodle, under the foot end of the Safety Seat until the level indicator shows level (Fig. 52-3). Re-tighten the vehicle seat belt as instructed in section **Securing the Safety Seat or Base in the Vehicle**.

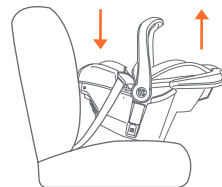

Fig. 52-2

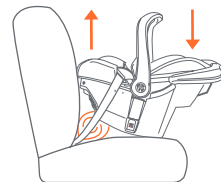

Fig. 52-3

7.5 Pool Noodle / Elevation Aids

- If the Seat Angle Indicator level line is not parallel with the ground, or the bubble is not centered, place a rolled towel, folded towel or pool noodle under the front of the base (Fig. 53-1), or at the foot end of carriers (Fig. 53-2), to achieve the correct position.
- A rolled towel, folded towel or pool noodle may be placed at the back of the base for elevation (Fig. 53-3).

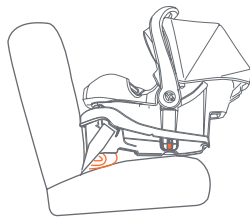

Fig. 53-1

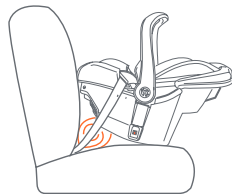

Fig. 53-2

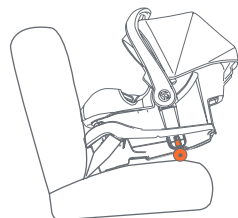

Fig. 53-3

7.6 Base Use

- When placing a pool noodle(s), rolled or folded towel ensure the elevation aid extends beyond the outside edge of the base by at least 1 inch (Fig. 54-1).

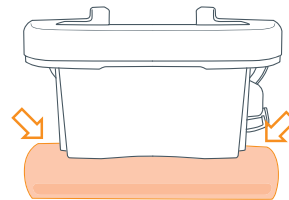
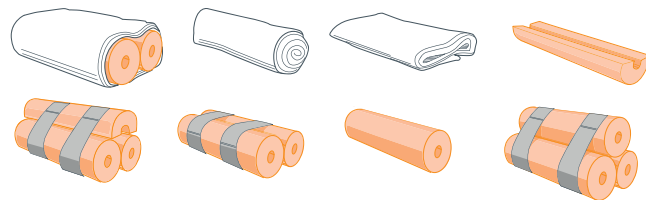

Fig. 54-1

7.7 Pool Noodle and Towel Examples but not limited to:



FINAL SAFETY CHECKS

8.1 Checking Safety Safety

1. If your child is already in the Safety Seat, check that the harness is properly fitted and tight as instructed in the section **6.1, Securing your Child in the Safety Seat / Carrier**.
2. Make sure that the Safety Seat is tightly installed and secure in the vehicle by performing the following test every time you use the Safety Seat. Firmly push down and side to side on the head end of the Safety Seat to make sure that the vehicle seat belt does not loosen at all and that the vehicle seat belt is fastened very tightly around the Safety Seat / Base. If you find that the vehicle seat belt loosens or that the seat easily moves or rotates downward, please see section entitled Selecting the Best Location for the Safety Seat to determine if the position you have selected is adequate and check that you have completed all of the steps in the section entitled Securing the Safety Seat or Base in the Vehicle.
DO NOT use this seating location if the Safety Seat does not remain tightly installed in the vehicle seat!
3. Remove any toys or other objects attached to carry handle
4. Adjust carry handle to an approved in-vehicle-use position.

ADDITIONAL INFORMATION

9.1 Using the Safety Seat in an Airplane

This Safety Seat may be used without the Base in an airplane in the same manner as it is used in an automobile. Please check with the airline in advance to determine their policies regarding the use of Safety Seats aboard the airplane. The Safety Seat must be used in only a forward facing airplane seat. Please ask the flight attendant for assistance in placement of the Safety Seat. Please follow these instructions for proper installation and perform the Final Safety Check as instructed herein.

9.2 Using your Baby Trend Safety Seat with a Baby Trend Stroller

Please see the stroller owner's manual for information on the use of the Safety Seat with the Baby Trend stroller.

9.3 Cleaning and Maintenance

The hard surfaces of the Safety Seat, (plastic components and metal parts). May be cleaned by wiping with a solution of water with mild soap. **DO NOT** use bleach as it may weaken plastic components. Dry all surfaces with a clean towel.

The Harness Straps may be spot cleaned with a solution of mild soap and water or may be replaced if they become overly soiled. **DO NOT** launder the straps as they may become damaged or weakened. Please contact Baby Trend customer service to order replacement harness straps.

DO NOT use lubricants of any kind on any of the components of the Safety Seat and Base, including the buckle and LATCH system.

The seat pad may be washed as follows:

1. Remove the harness shoulder straps from the Safety Seat as instructed in the section **Adjustment of the Shoulder Straps**.
2. For the 5-point harness, unthread the shoulder strap from the Harness-tie and Buckle Tongues, leaving the Buckle Tongues in the Buckle. Be sure to note how they are threaded to assist in reassembling.
3. For the Adjustable Back Safety Seat, carefully remove the headrest fabric then adjust the Adjustable Back to its lowest position. Carefully remove the seat fabric. For the Fixed Back Safety Seat, carefully remove the seat fabric. For 5-point harness models, do not unthread the lower portion of the harness from the Safety Seat.

DO NOT use the Safety Seat Without the Seat Pad.

4. For care and maintenance see fabric tag.
 5. Reinstall seat pad on Safety Seat when dry being careful to reassemble the shoulder straps at the appropriate height as described in section **Adjustment of the Shoulder Straps**.
- For the 5-point harness models, place seat pad on Safety Seat, threading the Harness straps through the Pad bottom slots and pulling the Buckle through the opening at the rear of the flap on

Pad. Thread the Harness Straps through Buckle Tongues and Harness-Tie. See section **Adjustment of the Shoulder Straps** for re-threading of shoulder straps.

- To re-install the Harness straps on the adjustable seat back model, move the Seat Back to its highest position, then follow steps in section **Adjustment of the Shoulder Straps**.

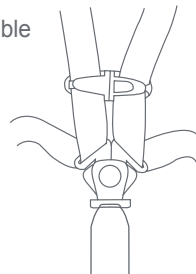

Inspect the Harness Straps from the front and rear to ensure that they are not twisted. Twisted straps can prevent proper tightening of the Harness and thus may not adequately restrain your child in a sharp turn, sudden stop or crash. Before using the Safety Seat, please pull on the Harness Straps from the front to ensure that they are securely re-attached.

9.4 Replacement Parts

If You Need Help or Replacement Parts, please call our Customer Service Department at **1-800-328-7363** between the hours of 8:00 a.m. and 4:30 p.m., Pacific Standard Time, Monday through Friday or visit us online at www.babytrend.com

WARRANTY

DO NOT RETURN YOUR PRODUCT TO THE STORE.
PLEASE CONTACT BABY TREND® FOR REPLACEMENT
PARTS, SERVICE AND REPAIR.

The Baby Trend® warranty covers workmanship defects within 1 year of purchase. Any product which has been subjected to misuse, abuse, abnormal use, excessive wear and tear, improper assembly, negligence, environmental exposure, alteration or accident, or has had its serial number altered or removed invalidates all claims against the manufacturer. Any damage to property during installation is the sole responsibility of the end user. Customer Service Department can be contacted at 1 (800). 328-7363 Monday through Friday between 8:00 a.m. and 4:30 p.m. (PST). Return Authorizations are required prior to returning product(s) to Baby Trend®. Please visit <http://babytrend.com/pages/limited-warranty> for complete warranty details.

GARANTIA

NO DEVUELVA SU PRODUCTO A LA TIENDA.
POR FAVOR CONTACTE A BABY TREND® PARA PIEZAS
DE REPUESTO, SERVICIO Y REPARACION.

La garantía de Baby Trend® cubre defectos de fábrica por 1 año después de la compra. Cualquier producto que haya sido sometido a uso inadecuado, abuso, uso anormal, desgaste excesivo, montaje incorrecto, negligencia, exposición ambiental, alteración o accidente, o cuyo número de serie haya sido alterado o removido, anula todos los reclamos contra el fabricante. Cualquier daño a la propiedad durante la instalación es la exclusiva responsabilidad del usuario final. El Departamento de Servicio al Cliente está disponible llamando al 1 (800). 328-7363, de lunes a viernes de 8:00 a. m. a 4:30 p.m. (PST). Se requiere una Autorización de Devolución antes de poder devolver el o los productos a Baby Trend®. Visite <http://babytrend.com/pages/limited-warranty> para conocer todos los detalles de la garantía.



If you experience any difficulty in using this product, please contact our customer service department at 1-800-328-7363 between the hours of 8:00 a.m. and 4:30 p.m. Pacific Standard Time for assistance. Please have your model number and manufacturing date available when you call. This information can be found on a small sticker on the bottom of the product.

Si experiència alguna dificultat al usar este producto, solicite ayuda llamando a nuestro departamento de servicio al cliente al 1-800-328-7363 en el horario de 8:00 a.m. a 4:30 p.m. Hora Estándar del Pacífico. Por favor, tenga a mano su número de modelo y la fecha de fabricación al llamar. Esta información se puede encontrar en una pequeña calcomanía que está en la parte inferior del producto.