

Store this manual in the pocket provided on the underside of the seat cover as illustrated above.

COVER ME
4-in-1

Para instrucciones en Español, conéctese a www.babytrend.com o llamar al: 1-800-328-7363.

 **babytrend**[®]
Quality • Comfort • Style

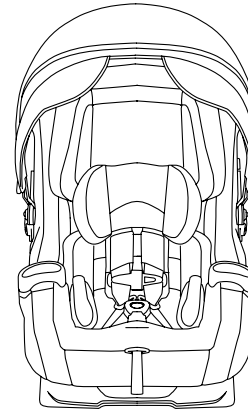
Baby Trend, Inc.
13048 Valley Blvd.
Fontana CA 92335

1-800-328-7363
(8:00am ~ 4:30pm PST)
www.babytrend.com

⚠ WARNING

Carefully read and understand all instructions and warnings in this manual. Failure to properly use this Car Seat increases the risk of **SERIOUS INJURY** or **DEATH** in a sudden stop or crash.

KEEP INSTRUCTIONS FOR FUTURE USE.
Store this manual in the pocket provided on the underside of the seat cover as illustrated on back cover of this manual.



Scan QR Code
for Cover Me™
How-To Videos

COVER ME
4-in-1

CV89XXXC
Cover Me™ 4-in-1 Convertible Car Seat
OWNER'S MANUAL

 **babytrend**[®]
Quality • Comfort • Style

Table of Contents

1.0	General Warnings and Information	3
2.0	Use Recommendations	5
2.1	Rear facing seat requirements	5
2.2	Forward facing seat requirements	6
3.0	Car Seat Parts	8
4.0	Selecting a Vehicle Seating Location	09
4.1	Overall Considerations In Selecting A Location	09
4.2	Proper Use And Requirements	11
4.3	Safe Vehicle Seat Belt Systems	12
4.4	Locking Clip Installation	15
4.5	Unsafe Vehicle Seat Belt Systems	16
4.6	Preparation for Installation in Vehicle	18
4.7	Installation with LATCH	19
4.8	LATCH - Top Tether Anchor Locations	20
5.0	Installation and Use Internal Harness Mode	21
5.1	Child Placement In Car Seat	22
5.1.1	Installation Diagrams	23
5.2	Rear Facing Lap/Shoulder Belt Installation	24
5.3	Rear Facing Lap Belt Installation	28
5.4	Rear Facing Installation with LATCH Lower Anchor	32
5.5	Forward Facing Installation with Lap Belt	36
5.6	Forward Facing Installation with Lap Shoulder Belt	40
5.7	Forward Facing Installation with LATCH	44
5.8	Aircraft Installation	48
5.9	Child Placement In Car Seat	49
5.10	Harness Shoulder Height Adjustment	53
5.11	Height Adjustment - No Re-thread Positions 3-7	54
5.12	Harness Height Adjustment Positions 1-2	55
5.13	Harness Length Adjustment	56
5.14	Car Seat Shoulder Height Positions	58
5.15	Base Recline	58
5.16	Rear-facing Recline Foot Use	60
5.17	Rear-facing Recline Foot Storage	60

Table of Contents

5.18	Canopy Use	61
5.19	Canopy Position Change	61
5.20	Independent Sun Side Visors	62
5.21	Canopy Opening and Closing	63
5.22	Harness Center Tension Adjuster	63
5.23	LATCH Top Tether and Lower Anchor J-Hook Storage	64
5.24	Changing LATCH Lower Anchor J-Hook use Positions	64
5.25	Crotch Buckle Adjustments	67
5.25.1	Belt Shortening Clip	68
5.26	Low Birthweight Harness Routing	70
5.27	Head Pillow, Body Insert and Harness Covers Use	77
5.28	Harness Hip and Buckle Use Positions	78
5.29	Cup Holder Removal, Installation and Cleaning	79
5.30	Seat Fabric / Laundering Seat Fabric Removal	80
6.0	Installation and Use - Booster Mode	81
6.1	Booster Use Requirements	81
6.2	Weight and Height Requirements	81
6.3	Booster Seat Use	81
6.4	Belt Position Booster Warnings	82
6.5	Booster Parts	83
6.6	Preparing Canopy for use in Booster Car Seat Mode	84
6.7	Booster Car Seat Installation without Canopy Use	85
6.8	Booster Car Seat Installation with Canopy Use	89
6.9	Harness System Removal for Booster Car Seat Installation	93
7.0	Additional Information	95
7.1	Certification	95
7.2	Aircraft Use	95
7.3	Vehicle Seat Protection	95
7.4	Instruction Manual Storage	96
7.5	Car Seat Useful Life	96
7.6	Replacements	96
7.7	Care and Cleaning	97
8.0	Registration Information	98
9.0	Warranty	99

1.0 General Warnings and Information

WARNING!

DEATH or SERIOUS INJURY can occur:

- Failure to follow these instructions and Car Seat labels can result in injury or death to a child from striking the vehicle's interior during a sudden stop or crash.
- Even if the Car Seat seems easy to use on your own, it is important to read these instructions and the vehicle owner's manual for details you might miss.
- The instructions in this manual and in your vehicle owner's manual must be followed carefully. If there is a conflict between the two, the vehicle owner's manual must be followed if it relates to the vehicle's seat belt, **LATCH** or airbags.
- Failure to use the vehicle seat belt or to adjust it properly can result in your child striking the vehicle's interior during a sudden stop or crash. Serious injury or death can occur.
- **DO NOT** allow others (babysitters, friends, grandparents, etc.). To use this Car Seat unless they read and understand the instructions and labels and can demonstrate proper use to your satisfaction.
- Use only Car Seat accessories manufactured by Baby Trend®. Accessories can affect your child's safety in a sudden stop or crash.
- **DO NOT** modify or attach any toys, seat fabric, or other items to this Car Seat. Untested modifications could result in injury in a crash.

1.0 General Warnings and Information

- Secure this Car Seat with the vehicle seat belt or **LATCH** Lower anchor j-hook connectors at all times (even when there is no child in it). An unsecured Car Seat can injure others if a crash occurs.
- Direct sunlight can make Car Seat surfaces hot enough to burn your child. Use caution and check the vehicle and Car Seat on hot, sunny days.
- **NEVER** leave child unattended under any circumstance.
- **DO NOT** use this Car Seat if it has been in a crash. (There may be hidden damage and it must be replaced). Your insurance company may provide some assistance replacing this Car Seat.
- **DO NOT** use this Car Seat if it is damaged in any way or has missing parts.
- **STOP USING THIS Car Seat AND PROPERLY DISPOSE** after the date on the back of the seat. **PROPERLY DISPOSE** in a dark trash bag. **DO NOT** sell to a thrift or consignment shop, at garage sales or flea markets.
- **NEVER** use this Car Seat in the home, on boats, in a motor home with side facing seat, low speed vehicles, golf carts, all terrain or other non certified uses. Only use the Car Seat in Vehicles and Aircraft.
- **NEVER** use this Car Seat in any vehicle seating position equipped with an active air bag. Read your vehicle's owners manual to see how to turn off your airbag if you have no back seat or a child must ride in the front seat covers. For side airbags see section 4.1 (Page 11).

The National Highway Traffic Safety Administration (NHTSA) recommends that children remain in a rear-facing car seat until they reach the height or weight limit set by the car seat's manufacturer, which is usually up to age 3.

2.0 Use Recommendations

- Baby Trend recommends children remain in a rear-facing car seat for as long as possible, until they reach the highest weight or height allowed by their seat and are at least 2 years of age.

2.1 Convertible Rear facing seat requirements

Weight and Height Requirements:

- The Car Seat, in a rear facing position (Fig. 5a) is designed for use by children whose:

- Weight is between 4 and 40 lbs (1.81 and 18.1 kg), and
- Height is 40 inches (102 cm) or less.
- Top of head has **NOT** reached 1" from top of seatback (Fig. 5b).

Child **MUST** meet **ALL** of these requirements to use this Car Seat rear facing.

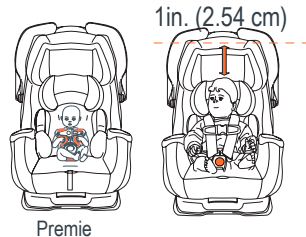
2.2 Forward facing seat requirements with Harness

Weight and Height Requirements:

- This Car Seat, installed in a forward facing position, is designed for use by children whose:-
- Weight is between 30 to 65 lb (13.6 to 29.5 kg)



Fig. 5a



Premie

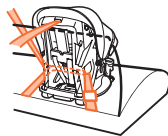


Fig. 5b

2.0 Use Recommendations

- Height is 50 inches (127 cm) or less.
- Age is at least 2 years old.
- The top of the child's ears must be at or below the top of the Car Seat (Fig. 6a).

Child **MUST** meet **ALL** of these requirements to use the Car Seat forward facing.

Top Ears Max Height

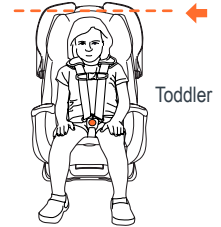


Fig. 6a

2.3 Belt Positioning Booster seat requirements

- Parents are advised that children should use a child restraint with a built-in harness system until they exceed the weight or height limits specified by the manufacturer.

Weight and Height Requirements:

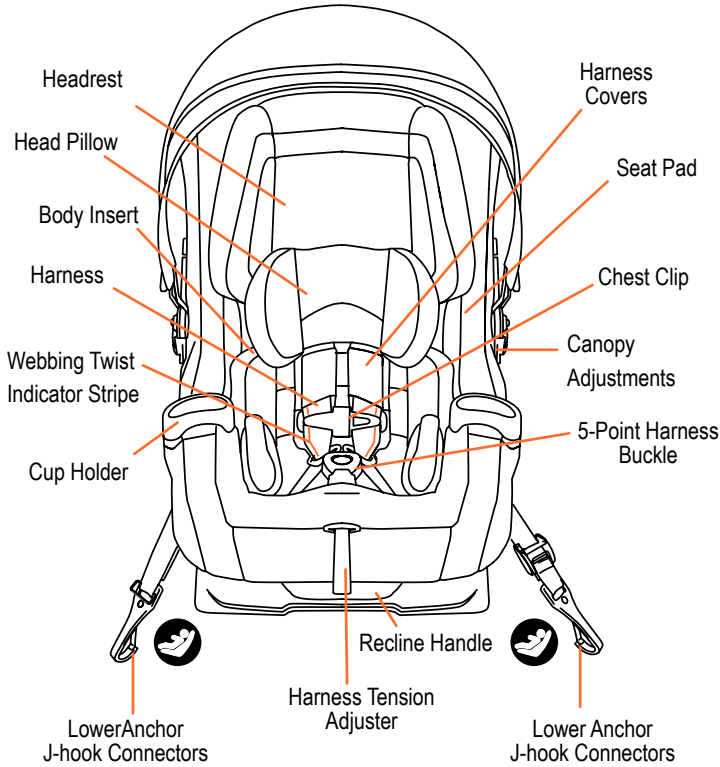
This Car Seat, installed a Belt Positioning Booster is designed for use by children whose:

- Age is 4 years or older, and
- Weight is between 40 and 100 lbs (18.1 and 45 kg), and
- Height is between 44 and 57 inches (112 and 145 cm).

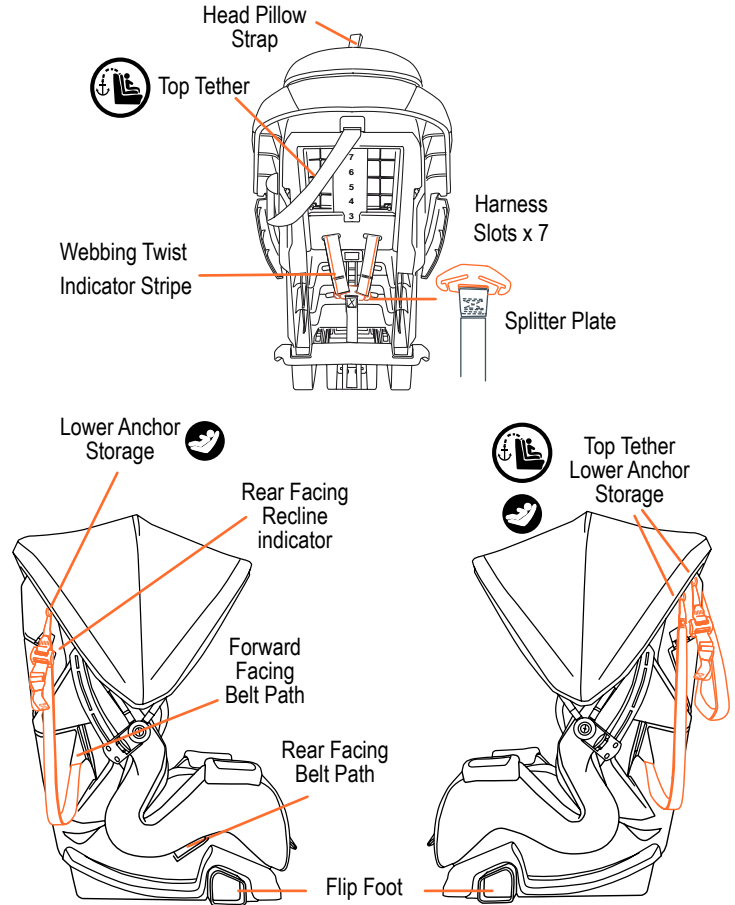


Fig. 6b

3.0 Car Seat Parts



3.0 Car Seat Parts



4.0 Selecting a Vehicle Seating Location

! WARNING!

DEATH or SERIOUS INJURY can occur:

- IMPROPER PLACEMENT OF THE Car Seat INCREASES THE RISK OF SERIOUS INJURY OR DEATH.

! WARNING!

- Not every location within an vehicle may be safe for the installation of this Car Seat. Car Seat must be tightly secured and remain tightly secured at all time. Some vehicles have no seating position installation of a Car Seat. Improper placement or use of a Car Seat that is not tightly secured in a vehicle will increase the risk of death or serious injury.
- Please follow the instructions in this manual and in your vehicle owner's manual carefully to ensure proper location and installation of the Car Seat. If you are uncertain about the proper location of the Car Seat within the vehicle, contact your vehicle manufacturer directly or through their dealer before using the Car Seat. You are also invited to call Baby Trend at 1-800-328-7363 for additional information or assistance.

4.1 Overall Considerations in Selecting a Location

- According to accident statistics, children are safer when properly restrained in rear vehicle seating positions, rather than front seating positions.

4.0 Selecting a Vehicle Seating Location

Whenever possible, this Car Seat should be secured in the rear center, seating position. The rear seat directly behind the front seats NOT in a third row rear seat (Fig. 10a).



Fig. 10a

- ONLY place in a forward-facing vehicle seat. DO NOT place this Car Seat in any vehicle seat that faces to the rear (Fig. 10b).
- DO NOT place this Car Seat in any vehicle seat that faces to either side of the vehicle (Fig. 10c).



Fig. 10b

- We recommend that you use the center rear seat position as the safest location for the Car Seat. In addition, whenever possible, have an adult ride in the rear with the child in order to monitor the child.



Fig. 10c

NOTE: LATCH system may not be available in the center rear seat position. Install with a vehicle seat belt if LATCH is not available.

- If the driver is the only adult in the vehicle and the child requires constant monitoring, then a vehicle front seating position may be used if there is no passenger side Active Frontal Air bag and all of the following requirements are met for this location.

4.0 Selecting a Vehicle Seating Location

4.2 Check that the Vehicle Seat Meets the Following Requirements

! WARNING!



DO NOT place rear-facing child seat on front seat with active frontal air bag. DEATH OR SERIOUS INJURY can occur. The back seat is the safest place for children 12 and under.

- **NEVER** place this Car Seat in a vehicle seating location that has an Active Frontal Air Bag! Active Air Bags inflate with great force! An inflating Air Bag can strike a Car Seat with enough force to cause death or serious injury to your child. If your vehicle is equipped with a front passenger side active air bag, please refer to the vehicle's owner's manual for additional information about active air bags and child Car Seat installation.
- **DO NOT** use this Car Seat in a vehicle that has a vehicle seatback that does not lock into place. A seatback that folds forward must have a latch or locking mechanism to prevent it from flying forward and striking the child in a sudden stop or accident.
- Please review your vehicle owner's manual to determine the best location for the Car Seat or to determine if any locations are unsafe for Car Seat installation. If you do not have the vehicle owner's manual or the owner's manual does not address child Car Seat installation, please contact the vehicle manufacturer to obtain this information before using this Car Seat.

4.0 Selecting a Vehicle Seating Location

VEHICLE SEAT BELT REQUIREMENTS

! WARNING!

DEATH or SERIOUS INJURY can occur:

- THE Car Seat **MUST BE TIGHTLY SECURED BY THE VEHICLE SEAT BELT AT ALL TIMES.** A VARIETY OF VEHICLE SEAT BELT SYSTEMS ARE AVAILABLE IN VEHICLES. SOME OF THESE VEHICLE SEAT BELT SYSTEMS ARE NOT SAFE FOR USE WITH THE Car Seat.

Even newer vehicles can have seat belts systems that are NOT safe for use with the Car Seat. These systems may look safe but their method of operation precludes their use with the Car Seat. If you are unsure if the vehicle seat belt is safe for use with the Car Seat, check the vehicle owner's manual or contact the vehicle manufacturer, or your vehicle dealer for additional information.

Baby Trend requires the use of the top tether for installation if the vehicle is equipped with a tether anchor. Please refer to the vehicle owner's manual for tether anchor locations.

4.3 SAFE Vehicle Seat Belt Systems

The following vehicle seat belt systems **CAN BE USED** with the Car Seat provided that all of the other requirements prescribed in these instructions, including seat position, secure installation and all instructions provided by your vehicle owner's manual, are followed.

4.0 Selecting a Vehicle Seating Location

Lap Belts (Manually Adjusted) A lap belt that is manually adjusted and will remain tightly adjusted around the Car Seat while the vehicle is in motion is suitable for use with the Car Seat. Pulling the belt through the buckle after the buckle is fastened tightens this type of seat belt (Fig. 13a).



Fig. 13a

Lap Belts with Automatic Locking Retractor (ALR) A lap belt that cannot be lengthened once it is fastened is suitable for use with the Car Seat. These seat belts often have an automatic locking retractor (ALR) that will allow the belt to be lengthened but once fastened, must be unbuckled and allowed to retract fully before allowing the belt to be lengthened again (Fig. 13b).



Fig. 13b

Combination Lap/Shoulder Belt with Locking Latch Plate A lap/shoulder combination seat belt with a latch plate that locks the lap belt into position is suitable for use with the Car Seat (Fig. 13c). Once this type of seat belt is fastened, the latch plate prevents the lap belt from loosening. This combination seat belt does not require a Locking Clip.



Fig. 13c

4.0 Selecting a Vehicle Seating Location

Combination Lap/Shoulder Belt with Sliding Latch Plate A combination lap/shoulder belt with a latch plate that can slide freely along the belt (Fig. 14a), is suitable for use with this Car Seat when the belt is locked to prevent movement of the Car Seat. If the vehicle belt includes a lockable retractor, the retractor **MUST** be locked or a locking clip **MUST** be used. If the vehicle belt does not include a lockable retractor then a locking clip (Fig. 14b), **MUST** always be used.



Fig. 14a

Contact Baby Trend at 1-800-328-7363 to obtain a Locking Clip.



Locking clip

Fig. 14b

Please refer to the vehicle owner's manual to determine if your vehicle lap/shoulder belt includes a lockable retractor and how to lock it.

4.0 Selecting a Vehicle Seating Location

4.4 Locking Clip Installation

Storage for the Locking Clip is provided on the backside of the Car Seat base (Fig. 15a). Contact Baby Trend® 1-800-328-7263 to acquire an approved Locking Clip.

1. Route the combination lap shoulder belt through vehicle belt path on Car Seat and buckle vehicle seat belt.
2. Tighten the buckled seat belt by pulling upward on the shoulder belt while pushing down on the Car Seat.
3. While maintaining downward pressure on the Car Seat, squeeze the vehicle shoulder belt and lap belt together just above the buckle to prevent it from moving. Unbuckle the vehicle seat belt, being careful to prevent movement of the buckle.
4. Secure the vehicle shoulder belt to the lap belt by using the Locking Clip 1.25 cm (1/2") from the buckle (Fig. 15b).
5. Re-buckle the seat belt and check that the seat belt is tightly adjusted and stays tight. Ensure that locking clip is secure on both belts.

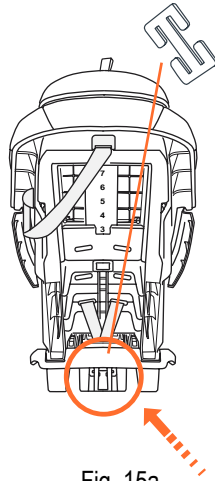


Fig. 15a

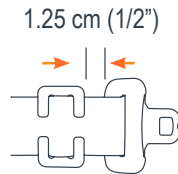


Fig. 15b

Test installation to make sure Car Seat is secure. If NOT secure, additional belt tightening is required. Repeat steps above until secure.

4.0 Selecting a Vehicle Seating Location

4.5 UNSAFE Vehicle Seat Belt Systems

DO NOT use the following types of seat belt systems with the Car Seat. These belt systems will not hold the Car Seat securely in place at all times. In addition, a locking clip will not make these belt systems safe to use. **NEVER USE** unsafe vehicle belts systems!

NOTE: LATCH can be used **IN PLACE OF** the following unsafe vehicle seat belts systems if your vehicle is equipped with LATCH anchorage system.

Lap Belts with Emergency Locking Retractor (ELR) **DO NOT** use a lap belt that stays loose after installed and locks only in a crash or sudden stop. These lap belts utilize an Emergency Locking Retractor (ELR) and are often found in combination with motorized shoulder belts. Because these belts will allow the Car Seat to move about on the vehicle seat, the chance of the Car Seat being out of the proper position in a crash is very high. Accordingly, **DO NOT** use the Car Seat with this type of seat belt system. Please see your vehicle's dealer or owner's manual for information on converting this seat belt system to one that is acceptable for use with a Car Seat (Fig. 16a).

Combination Lap/Shoulder Belt with Retractor

DO NOT use a lap/shoulder belt system if the lap belt and shoulder belt each have retractors at one end. This type of seat belt system will not adequately restrain the Car Seat (Fig. 16b).



Fig. 16a



Fig. 16b

4.0 Selecting a Vehicle Seating Location

Passive Restraint – Lap or Shoulder Belt Mounted on Door DO NOT use a seat belt that is connected to the door in any way. These types of seat belts are designed to automatically surround the occupant when the door is closed. This type of seat belt will **NOT** adequately restrain the Car Seat (Fig. 17a).



Fig. 17a

Passive Restraint – Lap Belt with Motorized Shoulder Belt DO NOT use a shoulder belt that moves along a track. These systems typically move to surround the occupant when the door is closed. This type of belt system will **NOT** adequately restrain the Car Seat (Fig. 17b).



Fig. 17b

Lap Belts Forward of Seat Crease DO NOT use a seat belt that is anchored on the seat more than 2 inches forward of the crease between the seat bottom and the seatback. This type of seat belt anchors the Car Seat too far forward and the Car Seat will not be safely restrained in the vehicle (Fig. 17c).



Fig. 17c

4.0 Selecting a Vehicle Seating Location

4.6 Preparation for Installation in Vehicle

When available, LATCH is the recommended method of securing the Car Seat in the vehicle.

DEATH or SERIOUS INJURY can occur:

- FAILURE TO PROPERLY SECURE THE Car Seat IN YOUR VEHICLE INCREASES THE RISK OF SERIOUS INJURY OR DEATH IN THE EVENT OF A SUDDEN STOP, SHARP TURN OR CRASH.
- National Highway Traffic Safety Administration (NHTSA) alerts vehicle owners that, according to accident statistics, children under age 13 are safer when properly restrained in the rear seating positions rather than in front seating positions.
- Use Car Seats in a vehicle's rear seat location whenever possible.

1. Park your vehicle on a level surface so that the Seat Angle Indicator located on the left side of the Car Seat will properly indicate the proper angle of recline of the seat.



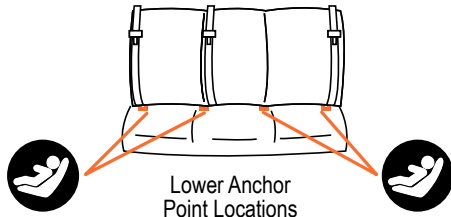
2. Make sure you have selected an acceptable location for the Car Seat as instructed in **Section 4.0 Selecting A Vehicle Seat Location**.

4.0 Selecting a Vehicle Seating Location

3. Check again for any active frontal air bags. **DO NOT** use a location that has an active frontal air bag or is adjacent to an Active Air bag such that, when deployed, the Active Air bag may come into contact with the Car Seat. Many passenger side frontal air bags are designed to deploy to protect the passenger side as well as the center front seating position. Please see the active air bag warnings in your vehicle owner's manual to help determine unsafe locations in the vehicle.
4. If the front seat position is used, slide the vehicle seat as far to the rear as possible to prevent the Car Seat from striking the dash in a crash. If the rear seat position is used, slide the vehicle seat directly in front of the Car Seat forward enough to prevent the Car Seat from striking the vehicle seatback in a crash.


4.7 Preparation for Installation with LATCH

Consult your vehicle owner's manual or manufacturer for location and availability of LATCH anchor points.
NOT all vehicles have the same locations or maximum weight requirements for LATCH!



4.0 Selecting a Vehicle Seating Location

4.8 LATCH - Top Tether Anchor Locations

Top Tether Locations are indicated by the following symbol: 

LATCH Top Tether symbol: 

Baby Trend requires the use of the top tether for installation if the vehicle is equipped with a tether anchor. Please refer to the vehicle owner's manual for tether anchor locations.

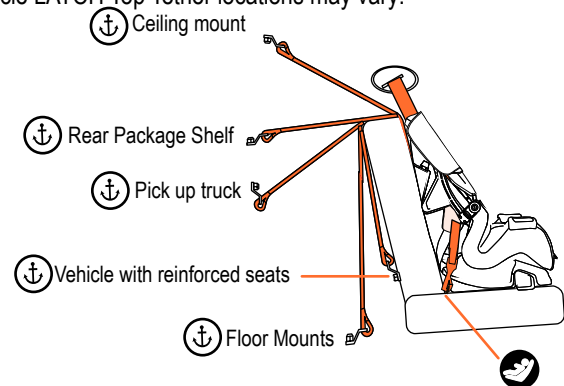
Consult your vehicle owner's manual for your vehicle's exact LATCH locations, anchor identification and usage requirements.

Maximum Child Weight for LATCH:

Lower Anchor 45 lbs (20.5 kg),

Top Tether 65 lbs (29.48 kg).

Vehicle LATCH Top Tether locations may vary:



5.0 Installation and Use Internal Harness Mode

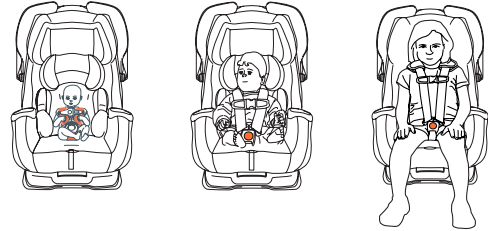
Baby Trend recommend children remain in a rear-facing Car Seat as long as possible, until they reach the highest weight or height allowed by their seat.

DEATH or SERIOUS INJURY can occur:

- Use only in a rear facing position when using the Car Seat with an infant weighing less than 22 lbs. (9.97kg).
- Use only with children who weigh between 4 - 65 lbs. (1.81 - 29.48 kg) and whose height is 50 inches (127 cm) or less. Forward facing 2 years and 30 to 65 lb (13.6 to 29.5 kg).
- Snugly adjust the belts (Harness) provided with the Car Seat around your child. Snug means you can not pinch webbing once buckled.
- Secure the top anchorage strap provided with this Car Seat.
- Secure this child seat with the vehicle's child restraint Anchorage system (LATCH) if available or with a lap/shoulder belt.
- Follow all instructions on the Car Seat and in the written instructions located under the cover. Do not use without instructions. Call 1-800-328-7363 to obtain instructions.
- Use vehicles seat belt (not LATCH) for children weighing more than 45 lbs (20.4 kg).
- Register your Car Seat with Baby Trend.
- **DO NOT** place rear facing child seat in a front seat that has an active airbag.
- **NEVER** leave child unattended under any circumstance.
- **DO NOT** use the lower anchors of the child restraint anchorage system (LATCH system) to attach this child restraint when restraining a child weighing more than 45 lbs (20.4 kg).

5.0 Installation and Use Internal Harness Mode

5.1 Child Placement in The Car Seat - Internal Harness Mode

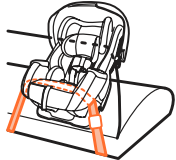


1. Place child in the Car Seat with the child's back flat against the back of the Car Seat and the child's bottom touching the seat.
2. Place harness straps over the child's shoulders.
NOTE: Check the height of the harness straps at the child's shoulders.
3. Place the crotch buckle in appropriate position. **See section 5.25 page 69.**
4. Insert the buckle tongues into the crotch buckle.
NOTE: Pull up and test buckle tongues to be sure they are secure.
5. Place chest clip at arm pit level. Insert chest clip tab and press together. Pull outward on chest clip's ends to be sure it is secure.
6. Pull on harness adjuster to tighten harness straps. A snug strap should not allow any slack. It lies in a relatively straight line without sagging. It does not press on to the child's skin or push the child's body into an unnatural position.

5.0 Installation and Use Internal Harness Mode

5.1.1 Installation Diagrams

Routing paths for Rear Facing installation



Lap belt

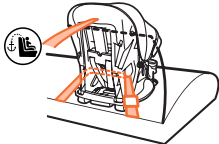


Lap/Shoulder belt

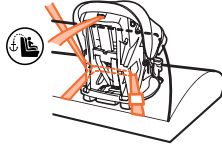


Lower anchor (LATCH)

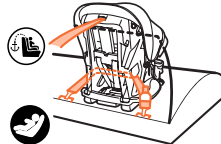
Routing paths for Forward Facing installation



Lap belt with top tether



Lap/Shoulder belt with top tether



Latch Lower anchor with top tether

⚠ WARNING!

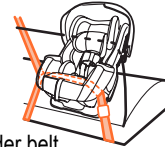
- Never use a Top Tether connector in a rear facing installation!!

5.0 Installation and Use Internal Harness Mode

5.2 Rear Facing Lap/Shoulder Belt Installation

See section 2.1 for requirements

- Weight is 4 - 40 lbs (1.81 - 18.1 kg).
- Height is 40 inches (102 cm) or less.
- Top of head has NOT reached 1" from top of seat back.



Lap Shoulder belt

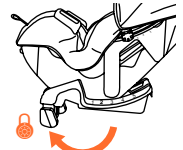
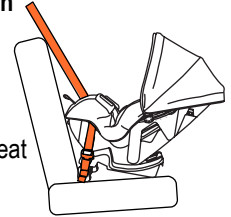
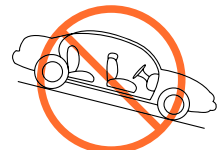


Fig. 24a

1. Extend the flip foot into position and ensure lock is engaged. To adjust the angle of the seat lift the recline handle. Use positions 1-3 for Rear facing (Fig 24a).

Angling the Car Seat will keep the baby's head back and airway open.

2. Make sure vehicle is parked on level ground then, place the Car Seat in a rear seating position and ensure vehicle is level.



5.0 Installation and Use Internal Harness Mode

3. Locate rear facing belt path openings (Fig. 25a).



Fig. 25a

4. Remove both cup holders by pressing the retention tab and set to the side (Fig. 25b).

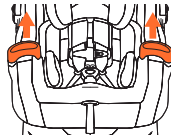


Fig. 25b

5. Pull the seat fabric back and route Lap Belt through the rear facing belt paths. **NOTE:** Remove any twist in webbing to ensure the webbing lies flat for securing the Car Seat to the vehicle (Fig. 25c).

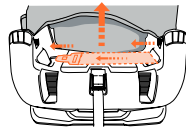


Fig. 25c

6. Insert the lap/shoulder belt buckle tongue into the buckle. Place your hand in the seat and push down on the seat while pulling up the lap/shoulder belt to tighten (Fig. 25d).

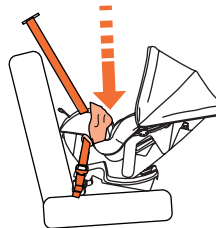


Fig. 25d

5.0 Installation and Use Internal Harness Mode

7. Pull up on buckle to ensure the buckle is secure.

NOTE: Refer to the vehicle owner's manual to determine if your vehicle lap/shoulder belt includes a lockable retractor and how to lock it.



Fig. 26a

8. Reinstall the cup holders. Please note **LH** or **RH** on bottom of cupholder. **LH** or **RH** refers to child's right and left (Fig. 26a).

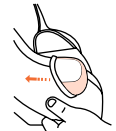


Fig. 26b

9. Pull seat fabric back over each cup holder (Fig. 26b), and then front of seat to secure (Fig. 26c).



Fig. 26c

5.0 Installation and Use Internal Harness Mode

10. Ensure the angle indicator bubble is centered between the lines for children 4-22 lbs. (1.81 - 9.97 kg) to keep the child's airway open. Ensure the angle indicator line is level with the ground for children 23-40 lbs (10.43 - 18.14 kg) to keep the child's airway open (Fig. 27a).

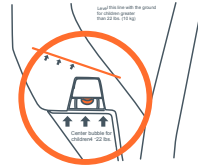
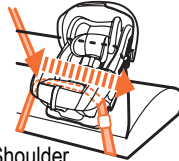


Fig. 27a

11. Check for movement of the Car Seat at the safety belt path. The Car Seat should not move more than 1 inch in any direction. If the Car Seat moves more than 1 inch, repeat all steps until all safety steps are met (Fig. 27b).



Lap Shoulder
belt

Fig. 27b

12. Place child in seat and secure harness. Recheck angle indicator to confirm the angle with the appropriate indicator by weight.

13. Harness covers, head pillow & body insert usage (Fig. 27c).

- **DO NOT** use head pillow if child's head falls forward.
- **DO NOT** use head pillow above shoulder position 3.
- **ONLY** use the body insert with children who weigh between 4-18 lbs.
- **Rear facing use only.**

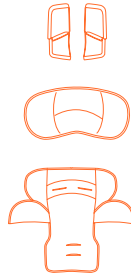


Fig. 27c

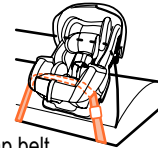
14. Repeat steps if necessary, after securing child.

5.0 Installation and Use Internal Harness Mode

5.3 Rear Facing Lap Belt Installation

See section 2.1 for requirements

- Weight is 4 - 40 lbs (1.81 - 18.1 kg).
- Height is 40 inches (102 cm) or less.
- Top of head has NOT reached 1" from top of seat back.



Lap belt

1. Extend the flip foot into position and ensure lock is engaged. To adjust the angle of the seat lift the recline handle. Use positions 1-3 for Rear facing (Fig. 28a).

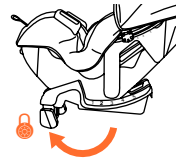


Fig. 28a

Angling the Car Seat will keep the baby's head back and airway open.

2. Make sure vehicle is parked on level ground then, place the Car Seat in a rear seating position and ensure vehicle is level.



5.0 Installation and Use Internal Harness Mode

3. Locate rear facing belt path openings (Fig. 29a).



Fig. 29a

4. Remove cup holder by pressing the retention tab and set to the side (Fig. 29b).

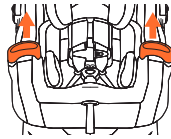


Fig. 29b

5. Pull the seat fabric back and route Lap Belt through the rear facing belt paths.

NOTE: Remove any twist in webbing to ensure the webbing lies flat for securing the Car Seat to the vehicle (Fig. 29c).

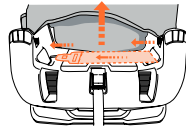


Fig. 29c

6. Insert the lap belt buckle tongue into the buckle. Place your hand in the seat and push down on the seat while pulling up the lap belt to tighten (Fig. 29d).

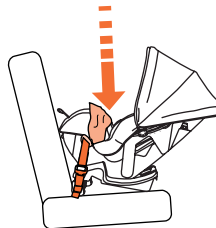


Fig. 29d

5.0 Installation and Use Internal Harness Mode

7. Pull up on buckle to ensure the buckle is secure.

8. Reinstall cup holder. Please note **LH** or **RH** on bottom of cupholder. **LH** or **RH** refers to child's right and left (Fig. 30a).



Fig.30a

9. Pull seat fabric back over each cup holder (Fig. 30b), and then front of seat to secure (Fig. 30c).

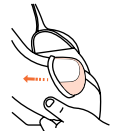


Fig. 30b



Fig.30c

5.0 Installation and Use Internal Harness Mode

10. Ensure the angle indicator bubble is centered between the lines for children 4-22 lbs. (1.81 - 9.97 kg) to keep the child's airway open. Ensure the angle indicator line is level with the ground for children 23-40 lbs (10.43 - 18.14 kg) to keep the child's airway open (Fig. 31a).

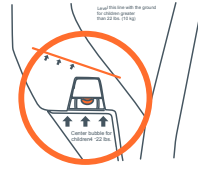


Fig. 31a

11. Check for movement of the Car Seat at the safety belt path. The Car Seat should not move more than 1 inch in any direction. If the Car Seat moves more than 1 inch, repeat all steps until all safety steps are met (Fig. 31b).



Lap Belt

12. Place child in seat and secure harness. Recheck angle indicator to confirm the angle with the appropriate indicator by weight.
13. Repeat steps if necessary, after securing child.

Fig. 31b

5.0 Installation and Use Internal Harness Mode

5.4 Rear Facing Installation with LATCH Lower Anchor

Requirements. See section 2.1:

- Weight is 4 - 40 lbs (1.81 - 18.1 kg).
- Height is 40 inches (102 cm) or less.
- Top of head has NOT reached 1" from top of seat back.



Lower Anchor

Place this Car Seat in a rear seating position designated as LATCH Lower Anchor compatible. Refer to your vehicle owner's manual for LATCH locations.

1. Extend the flip foot into position and ensure lock is engaged. To adjust the angle of the seat lift the recline handle. Use positions **1-3** for Rear facing (Fig. 32a).



Fig. 32a

Angling the Car Seat will keep the baby's head back and airway open.

2. Make sure vehicle is parked on level ground then, place the Car Seat in a rear seating position and ensure vehicle is level.



5.0 Installation and Use Internal Harness Mode

3. Locate rear facing belt path openings (Fig. 33a).
4. Remove both cup holders by pressing the retention tab and set to the side (Fig. 33b).
5. Pull the seat fabric back and route LATCH Lower Anchor J-Hook connector through the rear facing belt paths.

NOTE: Remove any twist in webbing to ensure the webbing lies flat for securing the Car Seat to the vehicle (Fig. 33c).

6. Attach the lower J-hook connector to the vehicle anchor used for LATCH. Place your hand in the seat. Push down while pulling strap end and hoop through the rear facing belt path to tighten Lower Anchor J-Hook sand strap (Fig. 33d).

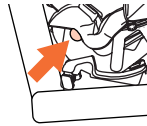


Fig. 33a

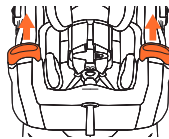


Fig. 33b

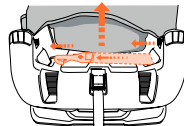


Fig. 33c

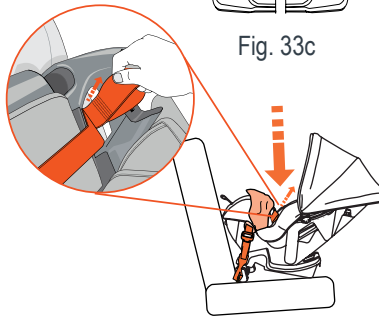


Fig. 33d

5.0 Installation and Use Internal Harness Mode

7. Pull up on each Lower Anchor J-Hook connector to ensure the lower anchor j-hook is securely fastened.
8. Reinstall the cup holders. Please note **LH** or **RH** on bottom of cupholder. **LH** or **RH** refers to child's right and left (Fig. 34a).
9. Pull seat fabric back over each cup holder (Fig. 34b), and then front of seat to secure (Fig. 34c).



Fig.34a

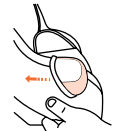


Fig. 34b

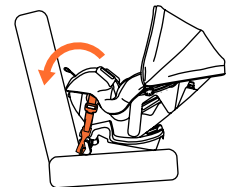


Fig.34c

5.0 Installation and Use Internal Harness Mode

10. Ensure the angle indicator bubble is centered between the lines for children 4-22 lbs. (1.81 - 9.97 kg) to keep the child's airway open. Ensure the angle indicator line is level with the ground for children 23-40 lbs (10.43 - 18.14 kg) to keep the child's airway open (Fig. 35a).

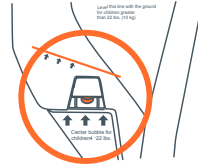


Fig. 35a

11. Check for movement of the Car Seat at the safety belt path. The Car Seat should not move more than 1 inch in any direction. If the Car Seat moves more than 1 inch, repeat all steps until all safety steps are met (Fig. 351b).

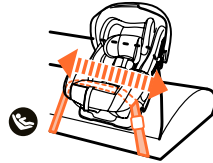


Fig. 35b

12. Place child in seat and secure harness. Recheck angle indicator to confirm the angle with the appropriate indicator by weight.

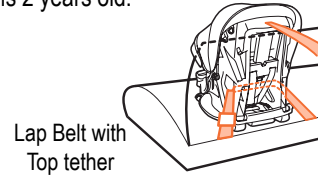
13. Repeat steps if necessary, after securing child.

5.0 Installation and Use Internal Harness Mode

5.5 Forward Facing Installation with Lap Belt

See section 2.2 for requirements

- Weight is 30 to 65 lb (13.6 to 29.5 kg).
- Height is 50 inches (127 cm) or less.
- Age is 2 years old.



1. Place this Car Seat in a rear seating position. Always adjust the base to position 5 or 4 (Fig. 36a) when forward facing. **NEVER** use base position 1, 2 or 3 in a forward-facing position. **DO NOT** extend flip foot out while in Forward Facing position.

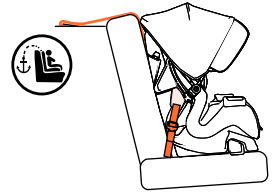
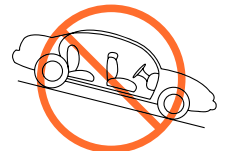


Fig.36a

2. Make sure vehicle is parked on level ground then, place the Car Seat in a rear seating position and ensure vehicle is level.



5.0 Installation and Use Internal Harness Mode

3. Remove body insert and head pillow and store for later rear-facing use (Fig. 37a).



Body Insert Head Pillow

Fig. 37a

4. Locate forward facing belt path openings (Fig. 37b).

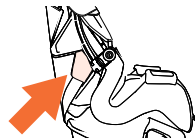


Fig. 37b

5. Loosen harness by pressing the center Tension adjuster and pulling on harness (Fig. 37c).

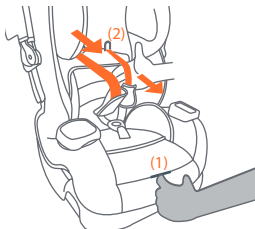


Fig. 37c

6. Lift seat fabric seat-back to expose the forward-facing belt path (Fig. 37d).

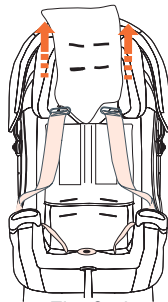


Fig. 37d

7. Route Lap Belt through the forward-facing belt path.

5.0 Installation and Use Internal Harness Mode

NOTE: Remove any twist in webbing to ensure the webbing lies flat for securing the Car Seat to the vehicle (Fig. 38a).

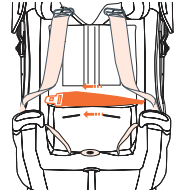


Fig.38a

8. Insert the lap belt buckle tongue into the buckle. Place your hand or knee in the seat and push down on the seat while pulling up the lap belt to tighten (Fig. 38b). Pull excess webbing at buckle tongue to tighten.

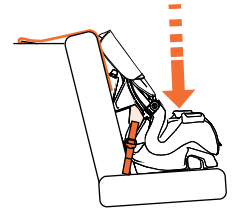


Fig.38b

9. Pull up on buckle as to ensure the buckle is secure.

10. Lower seat fabric seat-back and press into position against the seat back (Fig. 38c).

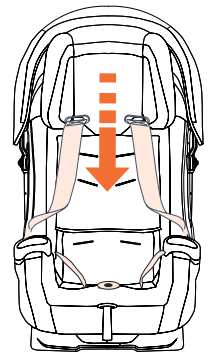


Fig. 38c

5.0 Installation and Use Internal Harness Mode

Baby Trend requires the use of the top tether for installation if the vehicle is equipped with a tether anchor. Please refer to the vehicle owner's manual for tether anchor locations.

11. Attach Top Tether to vehicle tether anchor (if available) (1) and (2). Listen for the "click" when the tether hook locks onto the vehicle tether anchor (Fig. 39a).

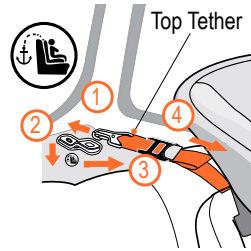


Fig. 39a

12. Pull on the Top Tether Strap to check that the Tether Hook is securely attached (3) (Fig. 39a).

13. Pull on free end of Top Tether Strap until all slack is removed from the Top Tether (4) (Fig. 38a).

NOTE: Your vehicle owner's manual will give the anchor locations and maximum weight of the Car Seat's occupant for LATCH connections.

14. Check for movement of the Car Seat at the safety belt path. The Car Seat should not move more than 1 inch in any direction. If the Car Seat moves more than 1 inch, repeat all steps until all safety steps are met (Fig. 39b).

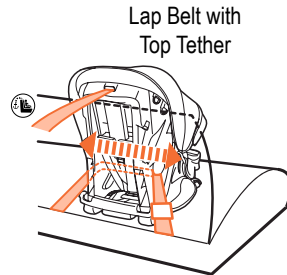


Fig. 39b

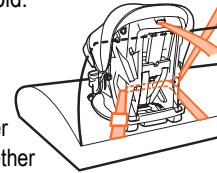
5.0 Installation and Use Internal Harness Mode

5.6 Forward Facing Installation with Lap Shoulder Belt

See section 2.2 for requirements.

- Weight is 30 to 65 lb (13.6 to 29.5 kg).
- Height is 50 inches (127 cm) or less.
- Age is 2 years old.

Lap/Shoulder Belt with Top Tether



1. Place this Car Seat in a rear seating position. Always adjust the base to position 5 or 4 (Fig. 40a) when forward facing. **NEVER** use base position 1, 2 or 3 in a forward-facing position. **DO NOT** extend flip foot out while in Forward Facing position.



Fig. 40a

2. Make sure vehicle is parked on level ground then, place the Car Seat in a rear seating position and ensure vehicle is level.



5.0 Installation and Use Internal Harness Mode

- Remove body insert and head pillow and store for later rear-facing use (Fig. 41a).



Body Insert Head Pillow

Fig. 41a

- Locate forward facing belt path openings (Fig. 41b).

- Loosen harness by pressing the center Tension adjuster and pulling on harness (Fig. 41c).

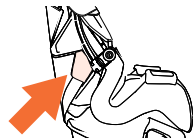


Fig. 41b

- Lift seat fabric seat-back to expose the forward-facing belt path (Fig. 41d).

NOTE: Remove any twist in webbing to ensure the webbing lies for securing the Car Seat to the vehicle.

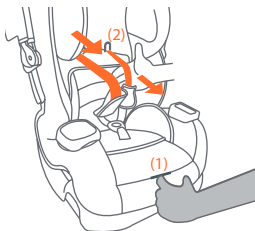


Fig.41c

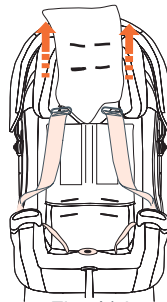


Fig. 41d

5.0 Installation and Use Internal Harness Mode

- Route Lap / Shoulder Belt through the forward-facing belt path (Fig. 42a).

NOTE: Remove any twist in webbing to ensure the webbing lies for securing the Car Seat to the vehicle.

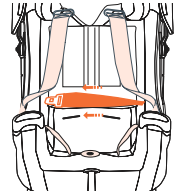


Fig.42a

- Insert the lap/shoulder belt buckle tongue into the buckle. Place your hand or knee in the seat and push down on the seat while pulling up the lap/shoulder belt to tighten (Fig. 42b). Pull excess webbing at buckle tongue to tighten.

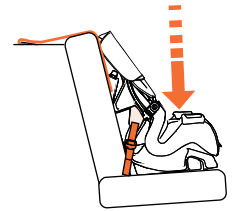


Fig.42b

- Pull up on buckle as to ensure the buckle is secure. Please refer to the vehicle owner's manual to determine if your vehicle lap/shoulder belt includes a lockable retractor and how to lock it.

- Lower seat fabric seat-back and press into position against the seat back (Fig. 42c).

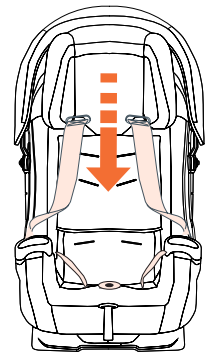


Fig.42c

5.0 Installation and Use Internal Harness Mode

11. Attach Top Tether to vehicle tether anchor (if available) (1) and (2). Ensure the tether hooks and locks onto the vehicle tether anchor (Fig. 43a).
12. Pull on the Top Tether Strap to check that the Tether Hook is securely attached (3).
13. Pull on free end of Top Tether Strap until all slack is removed from the Top Tether (4) (Fig. 43a).

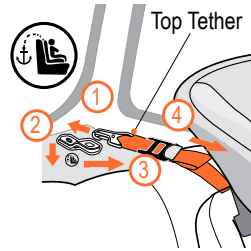
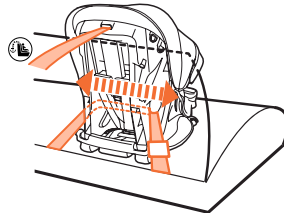


Fig. 43a

- NOTE:** Your vehicle owner's manual will give the anchor locations and maximum weight of the Car Seat's occupant for LATCH connections.
14. Check for movement of the Car Seat at the safety belt path. The Car Seat should not move more than 1 inch in any direction. If the Car Seat moves more than 1 inch, repeat all steps until all safety steps are met (Fig. 43b).



Lap / Shoulder Belt
with Top Tether

Fig. 43b

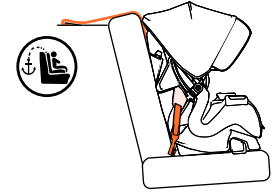
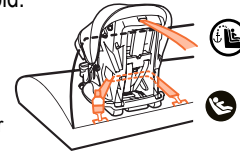
5.0 Installation and Use Internal Harness Mode

5.7 Forward Facing Installation with LATCH

Requirements. See section 2.2

- Weight is 30 to 65 lb (13.6 to 29.5 kg).
- Height is 50 inches (127 cm) or less.
- Age is 2 years old.

LATCH Lower Anchor with Top Tether



DO NOT install by this method for a child weighing more than 45 lbs. (20.4 kg.)

DO NOT use the lower anchors of the child restraint anchorage system (LATCH system) to attach this child restraint when restraining a child weighing more than 45 lbs (20.4 kg).

1. Place this Car Seat in a rear seating position. Always adjust the base to position 5 or 4 (Fig. 44a) when forward facing. **NEVER** use base position 1, 2 or 3 in a forward-facing position. **DO NOT** extend flip foot out while in Forward Facing position.
2. Make sure vehicle is parked on level ground then, place the Car Seat in a rear seating position and ensure vehicle is level.



Fig. 44a



5.0 Installation and Use Internal Harness Mode

3. Remove body insert and head pillow and store for rear-facing use (Fig. 45a).
4. Locate forward facing belt path openings (Fig. 45b).
5. Loosen harness by pressing the center Tension adjuster and pulling on harness (Fig. 45c).
6. Lift seat fabric seat-back to expose the forward-facing belt path (Fig. 45d).

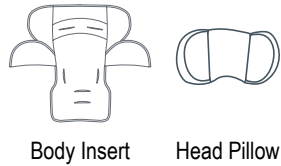


Fig. 45a

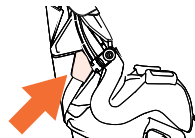


Fig. 45b

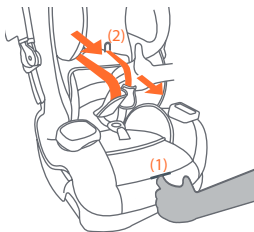


Fig. 45c

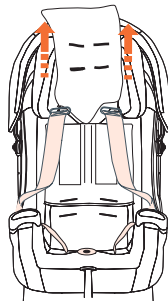


Fig. 45d

5.0 Installation and Use Internal Harness Mode

7. Route LATCH Lower Anchor J-Hook connector through the forward-facing belt path (Fig. 46a).
NOTE: Remove any twist in webbing to ensure the webbing lies for securing the Car Seat to the vehicle.
8. Attach the Lower Anchor J-Hook connector onto the vehicle anchor point. Place your hand or knee in the seat and push down on the seat while pulling on free end of Lower Anchor J-Hook Connector until all slack is removed from Lower Anchor (Fig. 46b).
9. Pull up on the Lower Anchor J-Hook connector to ensure the Lower Anchor J-Hook is securely fastened to the automobile LATCH bar.
10. Lower seat fabric seat-back and press into position against the seat back (Fig. 46c).

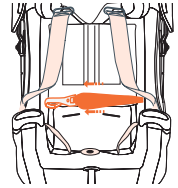


Fig. 46a

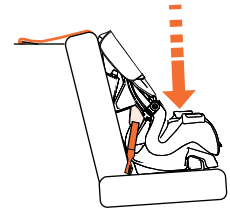


Fig. 46b

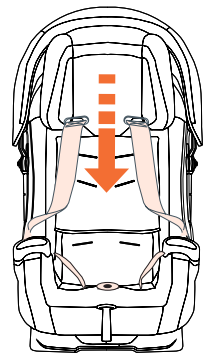


Fig. 46c

5.0 Installation and Use Internal Harness Mode

11. Attach Top Tether to vehicle tether anchor (if available) (1) and (2). Ensure the tether hooks and locks onto the vehicle tether anchor (Fig. 47a).
12. Pull on the Top Tether Strap to check that the Tether Hook is securely attached (3).
13. Pull on free end of Top Tether Strap until all slack is removed from the Top Tether (4) (Fig. 47a).

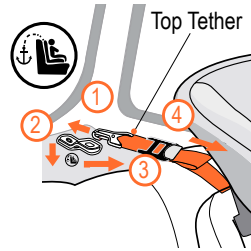
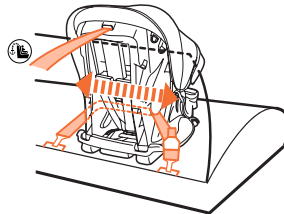


Fig. 47a



LATCH
Lower Anchor
with Top Tether

Fig. 47b

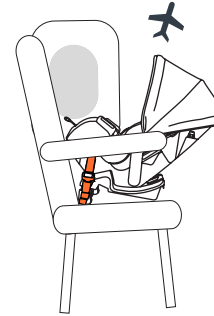
14. Check for movement of the Car Seat at the safety belt path. The Car Seat should not move more than 1 inch in any direction. If the Car Seat moves more than 1 inch, repeat all steps until all safety steps are met (Fig. 47b).

DO NOT use the lower anchors of the child restraint anchorage system (LATCH system) to attach this child restraint when restraining a child weighing more than 45 lbs (20.4 kg).

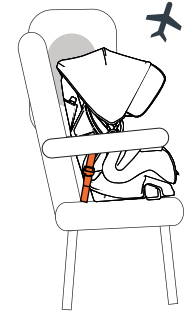
5.0 Installation and Use Internal Harness Mode

5.8 Aircraft installation - Harness Mode

1. Follow the seat belt installation for use in an Aircraft Installation.



Rear Facing
Aircraft Installation



Forward Facing
Aircraft Installation

NEVER install a Booster Car Seat on an aircraft because aircraft do not have shoulder belts.

2. Consult your airline for requirements to use the Car Seat.

5.0 Installation and Use Internal Harness Mode

5.9 Child Placement In The Car Seat

1. Loosen harness straps by pressing the Harness Tension Adjuster Button and pulling the Harness straps toward you (Fig. 49a).
2. Open Harness Clip by pressing button and sliding apart (Fig. 49b).
3. Spread harness and place on side of Car Seat (Fig. 49c).
4. Place your child in the Car Seat so that the child's bottom is against the back and bottom of the seat (Fig. 49d).

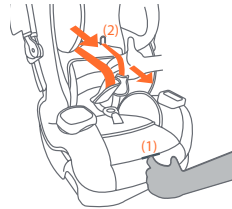


Fig. 49a



Fig. 49b

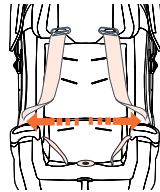


Fig. 49c

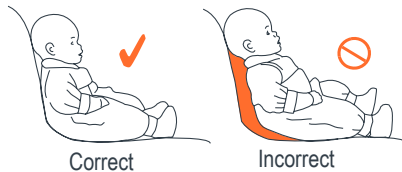


Fig. 49d

5.0 Installation and Use Internal Harness Mode

5. Check that the harness straps are located at the proper height for your child.

The **Rear-Facing** proper height of the harness straps is at or just below your child's shoulders (Fig. 50a).

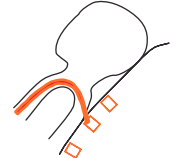


Fig. 50a

The **Forward-Facing** proper height of the harness straps is at or just above your child's shoulders (Fig. 50b). (See section 5.10 Harness Shoulder Height Adjustments).

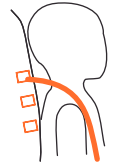


Fig. 50b

6. Place harness straps over the child's shoulders.

NOTE: Harness covers are required for all harness modes except for low birthweight routing (Fig. 50c).



Fig. 50c

7. The Car Seat has been safety tested with the harness covers, body insert and head pillow that are included with this Car Seat (Fig. 50d).

DO NOT use head pillow if child's head falls forward. Continued next page.

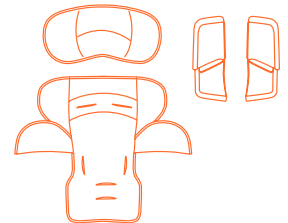


Fig. 50d

5.0 Installation and Use Internal Harness Mode

5.9.1 Child Placement In The Car Seat Continued

8. Harness Covers, head pillow & body insert cont.
- **DO NOT** use head pillow if child's head falls forward.
 - **DO NOT** use head pillow above shoulder position 3.
 - **ONLY** use the body insert with children who weigh between 4-18 lbs.
 - **Rear facing use only** (Fig. 51a).
 - Harness covers are required for all harness modes except for low birthweight routing.

9. Insert the buckle tongues into the buckle (Fig. 51b).

NOTE: Pull up and test buckle tongues to be sure they are secure.

10. Place chest clip at arm pit level (Fig. 51c). Insert chest clip tabs and press together (Fig. 51d). Pull outward on chest clip's ends to be sure, it is secure.

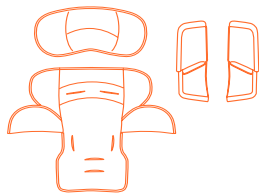


Fig. 51a

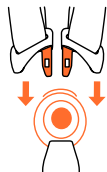


Fig. 51b



Fig. 51c



Fig. 51d

5.0 Installation and Use Internal Harness Mode

11. Pull on the harness tension adjuster to tighten harness straps. The strap should not allow any slack. The strap should not press on to the child's skin or push the child's body into an unnatural position. Harness Covers are required in all forward facing and rear facing position except the Low Birth weight harness routing (Fig. 52a).

To Loosen Harness System Tension, press the harness tension adjuster button (Fig. 52b) located underneath the seat fabric and gently pull out on the harness straps over the child's shoulder.

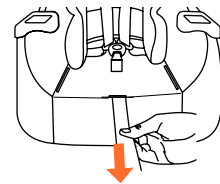


Fig. 52a

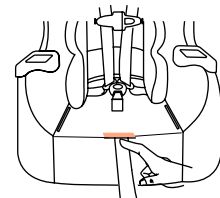


Fig. 52b

5.0 Installation and Use Internal Harness Mode

5.10 Harness Shoulder Height Adjustment

1. Shoulder Height Positions include:
Rear Facing: Positions **1, 2, 3** and **4**.
Forward Facing: Positions **5, 6** and **7**
(Fig. 53a).

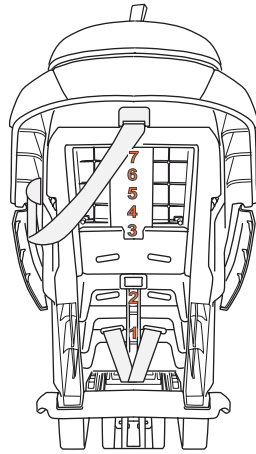


Fig. 53a

2. Height Selection - Ensure the harness straps are located at the proper height for your child.

The **Rear-Facing** proper height of the harness straps are at or just below your child's shoulders (Fig. 53b).



Fig. 53b

The **Forward-Facing** proper height of the harness straps are at or just above your child's shoulders (Fig. 53c).



Fig. 53c

5.0 Installation and Use Internal Harness Mode

5.11 Height Adjustment - No Re-thread Positions 3-7

1. Loosen harness straps by pressing the Harness Tension Adjuster Button and pulling the Harness straps toward you (Fig. 54a).
2. Squeeze the blue headrest adjustment buttons **(1)** and lift by headrest webbing loop to desired position **(2)** (Fig. 54b) Release blue headrest adjustment buttons to lock into desired position.
3. After hearing audible click confirm headrest is locked into desired position by pulling up and pushing down on headrest (Fig. 54c).

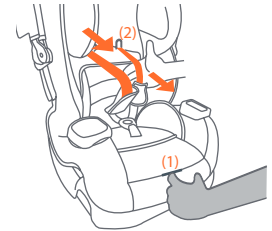


Fig. 54a

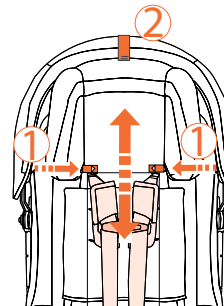


Fig. 54b

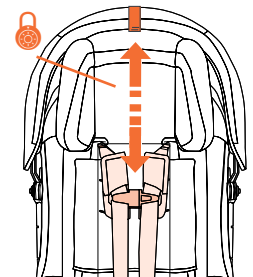


Fig. 54c

5.0 Installation and Use Internal Harness Mode

5.12 Harness Height Adjustment Positions 1 & 2

Harness shoulder height positions 1 & 2:

- **Rear-facing use only.**
- Lower birthweight children.
- Low birthweight routing.

1. Loosen harness straps by pressing the Harness Tension Adjuster Button and pulling the Harness straps toward you (Fig. 55a).
2. From the backside of the Car Seat unfasten harness end loops from metal plate (Fig. 55b).

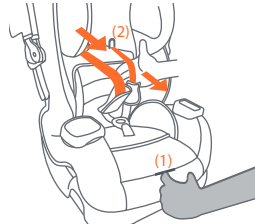


Fig. 55a

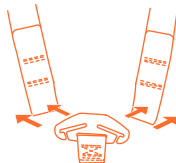
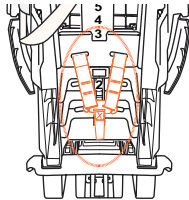


Fig. 55b

5.0 Installation and Use Internal Harness Mode

5.13 Harness Length Adjustment

3. From the front side pull harness end loops through seatback (Fig 56a).
4. Thread harness end loops through seatback to desired shoulder position **1** or **2** (Fig 56b).
NOTE: The Rear-Facing proper height of the harness straps is at or just below your child's shoulders.
5. From backside fasten harness end loop A to metal plate. (Fig 56c).

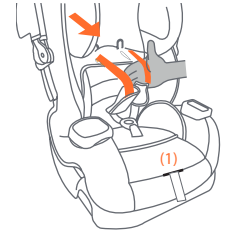


Fig. 56a



Fig. 56b

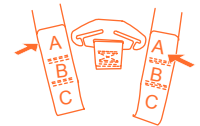


Fig. 56c

5.0 Installation and Use Internal Harness Mode

5.13.1 Harness Length Adjustment Continued

6. Fold webbing over metal plate and secure with hook and loop fastener (Fig 57a).
7. Ensure the harness strap ends are fully hooked on the metal plate. Both sides must be threaded in the same position (Fig 57b).
8. Place child in Car Seat and secure harness to confirm proper shoulder height position.

NOTE: The Rear-Facing proper height of the harness straps are at or just below your child's shoulders.



Fig. 57a

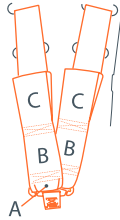


Fig. 57b



Fig. 57c

5.0 Installation and Use Internal Harness Mode

5.14 Car Seat Shoulder Height Positions

1. There are 7 shoulder height positions on this Car Seat (Fig. 58a).
 - Forward-Facing Positions **5, 6** and **7**.
 - Rear-Facing Positions **1, 2, 3** and **4**.

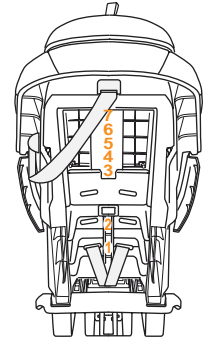


Fig. 58a

5.15 Base Recline

1. There are 5 adjustments positions on this Car Seat (Fig. 58b).
2. Base recline adjustment located at front of Car Seat. Lift blue Recline handle to release and rotate Car Seat into desired position (Fig. 58c).



Fig. 58b

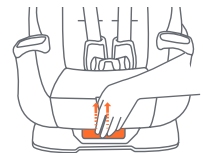


Fig. 58c

5.0 Installation and Use Internal Harness Mode

5.15.1 Base Recline Continued

3. Forward-Facing Positions (Fig. 59a)

4 and 5.

NOTE: Position 5 is the approved position Belt Positioning Booster mode.



Fig. 59a

4. Rear-Facing Positions (Fig. 59b)

1, 2, and 3.

5.16 Rear-facing Recline Foot Use

For elevation only in a rear-facing position this Car Seat has a flip foot that is released by the following steps.

1. From bottom side of Car Seat base press blue release handle down to release recline foot (Fig. 59c).

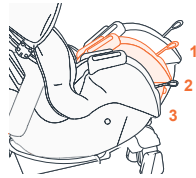


Fig. 59b

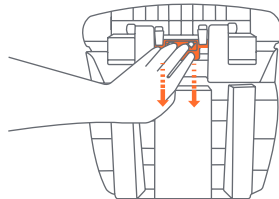


Fig. 59c

5.0 Installation and Use Internal Harness Mode

2. Rotate recline foot from bottom side of base until the foot is in the locked position (Fig. 60a).

3. After hearing audible click confirm recline foot is locked into position by moving the recline foot in a horizontal motion (Fig. 60b).

NOTE: A rolled towel or pool noodle can be used for extra elevation

5.17 Rear-facing Recline Foot Storage

1. To return to the storage position press on the blue release handle. Rotate the recline foot until locked into storage position (Fig. 60c).

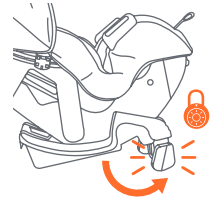


Fig. 60a

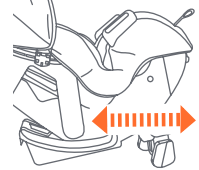


Fig. 60b

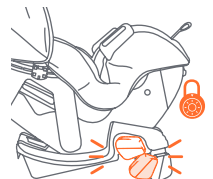


Fig. 60c

5.0 Installation and Use Internal Harness Mode

5.18 Canopy Use

1. The canopy can be used in forward-facing (Fig. 61a) and rear-facing (Fig. 61b) positions. Canopy use is not mandatory.

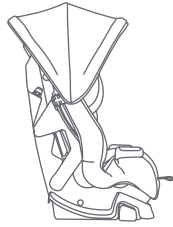


Fig. 61a

5.19 Canopy Position Change

1. There are 5 use positions for the canopy (Fig. 61c).

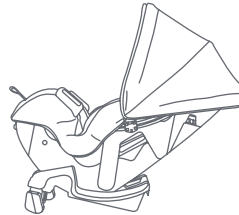


Fig. 61b

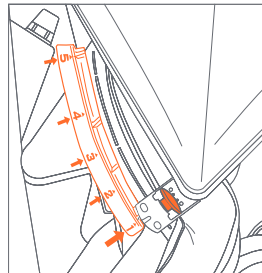


Fig. 61c

5.0 Installation and Use Internal Harness Mode

2. Before changing position ensure there is enough webbing adjusted through the canopy retention webbing located at the top of the Car Seat (Fig. 62a).
3. To change positions, press the blue canopy release on both sides simultaneously and slide to the desired position (Fig. 62b).

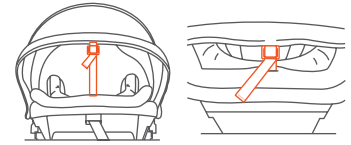


Fig. 62a

5.20 Independent Canopy Sun Side Visors

1. To store side visors, grasp and flip under canopy. To use, grasp and flip down (Fig. 62c).

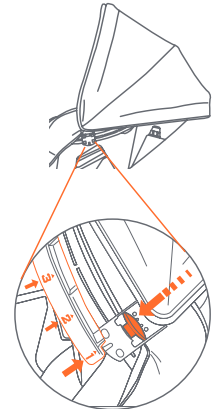


Fig. 62b

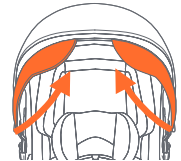


Fig. 62c

5.0 Installation and Use Internal Harness Mode

5.2.1 Canopy Opening and Closing

1. To open canopy, grasp, forward canopy hoop at the center and pull to fully open position (Fig. 63a).

NOTE: the canopy ratchets and locks into position.

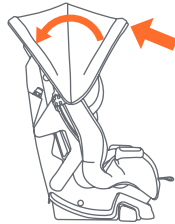


Fig. 63a

2. To close canopy, grasp, at center and push to close.

5.2.2 Harness Center Tension Adjuster

1. To tighten the harness system, pull on harness adjuster to tighten harness straps to a snug fit (Fig. 63b).

FIT NOTE: A snug strap should not allow any slack. It lies in a relatively straight line without sagging. It does not press on to the child's skin or push the child's body into an unnatural position.

2. To loosen harness system, Loosen harness straps by pressing the Harness Tension Adjuster Button 1 and pulling the Harness straps toward you 2 (Fig. 63c).

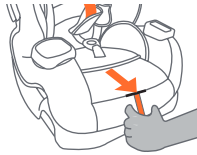


Fig. 63b

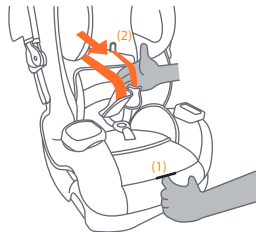


Fig. 63c

5.0 Installation and Use Internal Harness Mode

5.2.3 LATCH Top Tether and Lower Anchor J-Hook Storage

1. When not in use the Top Tether and Lower Anchor J-Hook has a storage location (Fig. 64a).

2. Lower Anchor J-Hook has an option storage position under the cupholders (Fig. 64b).

Top Tether
Lower Anchor
Storage

Fig. 64a

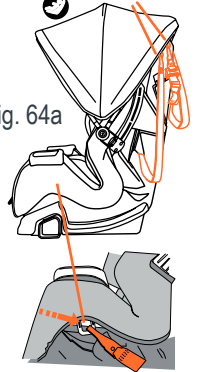
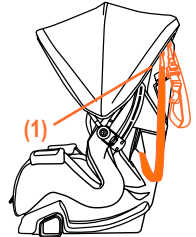


Fig. 64b

5.2.4 Changing LATCH Lower Anchor J-Hook use Positions

1. To move Lower Anchor J-Hook from forward-facing use to rear-facing use. Unclip Lower Anchor J-Hook from storage position that is next to the top tether storage (Child's left side) (1).



5.0 Installation and Use Internal Harness Mode

5.24.1 Changing LATCH Lower Anchor J-Hook Use Positions Cont.

2. Pull unclipped Lower Anchor J-Hook of the lower anchor through the **forward-facing** belt path (Fig. 65a).
3. Lift soft goods to expose the **rear-facing** belt and feed the Lower Anchor J-Hook end that was unclipped from the child's left side. Unclip Lower Anchor J-Hook from child's right side (Fig. 65b).
4. Attach Lower Anchor J-Hooks **rear-facing** Lower Anchor J-Hook storage located under the cupholders and lower soft goods into place and secure (Fig. 65c).

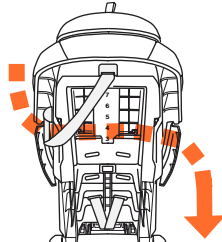


Fig. 65a

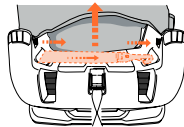


Fig. 65b



Fig. 65c

5.0 Installation and Use Internal Harness Mode

5.24.2 Changing LATCH Lower Anchor J-Hook Use Positions Cont.

5. To move Lower Anchor J-Hook from **rear-facing** use to **forward-facing** use. Unclip Lower Anchor J-Hook from storage position that is under the cup holder on the child's left side (Fig. 66a).
6. Lift soft goods to expose the **rear-facing** belt and feed the Lower Anchor J-Hook end that was unclipped from the child's left side (Fig. 66b).
7. Feed unclipped Lower Anchor J-Hook through the **forward-facing** belt path. Unclip Lower Anchor J-Hook from child's right side. Secure Lower Anchor J-Hooks to designated storage positions on the child's left and right side (Fig. 66c).



Fig. 66a

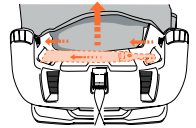


Fig. 66b

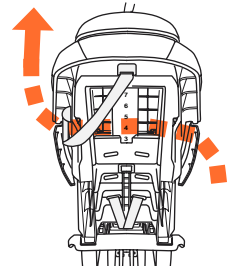


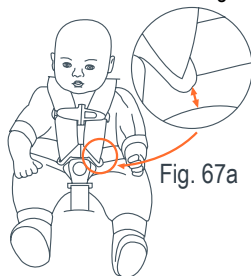
Fig. 66c

5.0 Installation and Use Internal Harness Mode

5.25 Crotch Buckle Adjustment

1. If the gap between the buckle and thigh is not between 1/2" and 1". The crotch strap length should be adjusted such that a gap of 1/2" to 1" is present between the ears of the buckle, and the top of the child's thigh, disregarding any clothing or diaper (Fig. 67a). Your child will grow very quickly so always check that the buckle is the proper height whenever placing your child in the Safety seat.

1/2 to 1 inch above thigh



The crotch strap length is adjusted as follows:

2. **To shorten** the buckle webbing length, thread the anchor bracket through the slot forward if using position 1 and the slot rearward if using position 2. Ensure the anchor bracket is completely through the slot. Pull on webbing from the bottom side to confirm its secured (Fig. 67b).

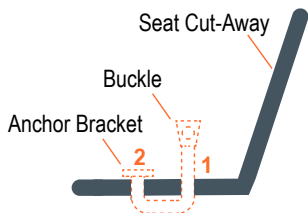
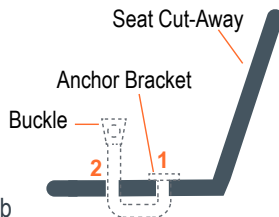
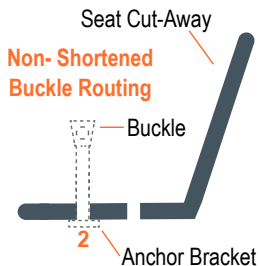


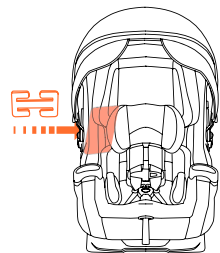
Fig. 67b



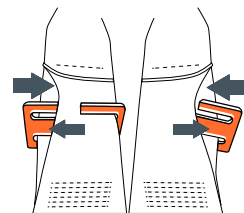
5.0 Installation and Use Internal Harness Mode

5.25.1 Belt Shortening Clip

NOTE: The Crotch Belt Shortening Clip is only to be used with children who's weight is between 4-10 lbs and if the gap between the buckle and thigh is not between 1/2" and 1". Contact [BabyTrend@ 1-800-328-7263](mailto:BabyTrend@1-800-328-7263) to acquire an approved Belt Shortening Clip. Use the manual pocket provided on the underside of the seat cover to store when not in use.



1. **Required:** Recline seat to position 1 (full recline) to access buckle anchor bracket and remove buckle assembly. See section (5.15 Base Recline page 58).



2. **Threading And Unthreading The Shortening Clip:** To unthread the Belt Shortening Clip push the strap from the side and slide it out through the clip opening. Flip over and repeat step 2 (Fig. 68a).

To thread insert the Belt Shortening Clip into the opening closest to the buckle and reverse step 2 (Fig. 68b).

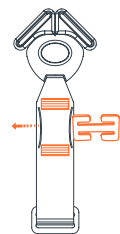
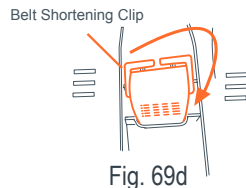
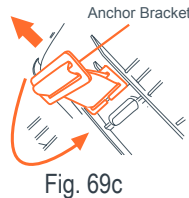
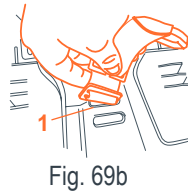
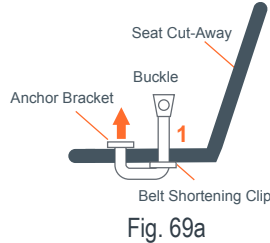


Fig. 68b

5.0 Installation and Use Internal Harness Mode

5.25.2 Belt Shortening Clip Continued

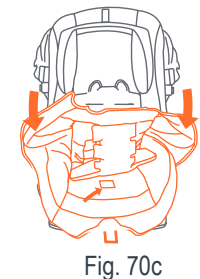
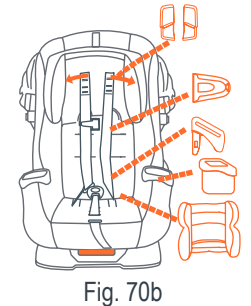
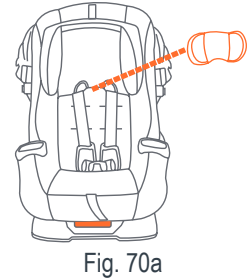
- View from Car Seat top side. Insert both the Anchor Bracket and the Belt Shortening Clip through the inner most slot, slot #1 (Fig. 69a) - (Fig. 69b).
- View from Car Seat underside. Pull slack as needed (Fig. 69c).
- View from Car Seat underside. After the Belt Shortening Clip is applied for “low birth weight”, thread the Anchor Bracket through the middle slot to stop any interference to this function or cause a mis-latch with shell and base (Fig. 69d). Pull on webbing to confirm its secured.



5.0 Installation and Use Internal Harness Mode

5.26 Low Birthweight Harness Routing

- Remove the head pillow (b) and store for future use. (Fig. 70a).
- Remove the harness loop ends from the splitter plate and pull harness through the seat back.
- Remove harness cover, chest clip and buckle tongue on child's left side and set aside. Remove the cup holders and set aside (Fig. 70b).
- Pull harness webbing through the body insert. Remove the body insert and set aside.
- Completely remove harness by pulling up on child's right side of webbing and set a side.
- Lift seat fabric from the top and pull crotch buckle through while removing the seat fabric. Do not remove headrest fabric (Fig. 70c).



5.0 Installation and Use Internal Harness Mode

5.26.1 Low Birth Weight Harness Shortening Routing Continued

7. **Required:** For steps 7 through 19 Adjust base recline to the full recline position 1. See section (5.15 Base Recline page 58).

8. **Required:** Use crotch buckle in position 1 and the belt shortening clip. Always put crotch buckle and place into position 1 and use the belt shortening clip (Fig. 71a). See section (5.25.1 Belt Shortening Clip page 68).

9. Pull the crotch buckle anchor and belt through to slot #2 (Fig. 71a).

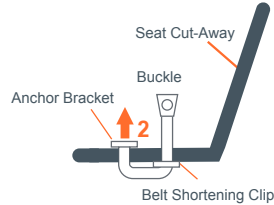


Fig. 71a

10. **DIAGRAM A:** From top side feed harness loop end down through seat slot (1).
11. Turn Car Seat over and feed harness loop end back up through seat slot (2).
12. **NOTE: DO NOT** thread outside of the recline mechanism. Turn car seat upright and feed harness loop end down seat slot (3).
13. On opposite side, Turn seat over and feed harness loop end up the opposing seat slot (3).
14. From top side feed harness loop end down through seat slot (2).
15. Turn seat over and feed harness end up through seat slot (1).

5.0 Installation and Use Internal Harness Mode

5.26.2 Low Birth Weight Harness Shortening Routing Continued

DIAGRAM A: Steps 10 to 15, Harness Route on pages 71

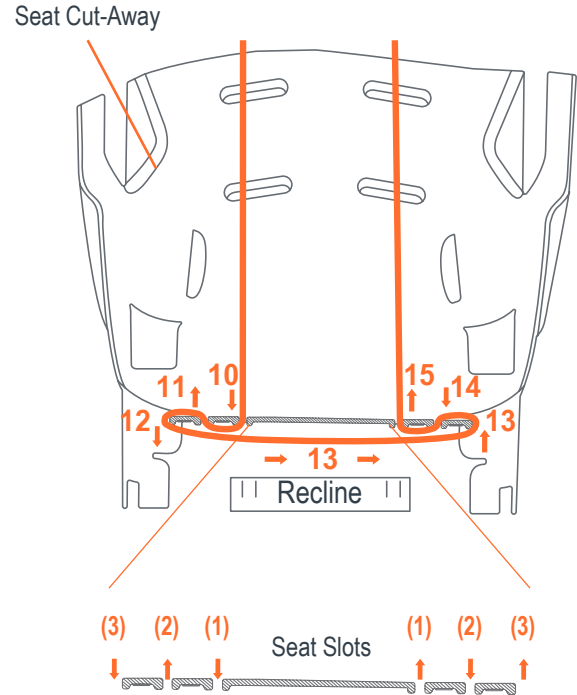


Diagram. A

5.0 Installation and Use Internal Harness Mode

5.26.3 Low Birth Weight Harness Shortening Routing Continued

16. Ensure the webbing twist indicator stripes are on the outer edges. From the top side pull harness end loop to pull excess webbing from bottom side.
17. Grasp both sides of harness end loops and pull up to equalize the harness length.
18. Ensure the harness end loops are the same length.
19. If harness length is not equal, pull webbing from long side of webbing to equalize length.

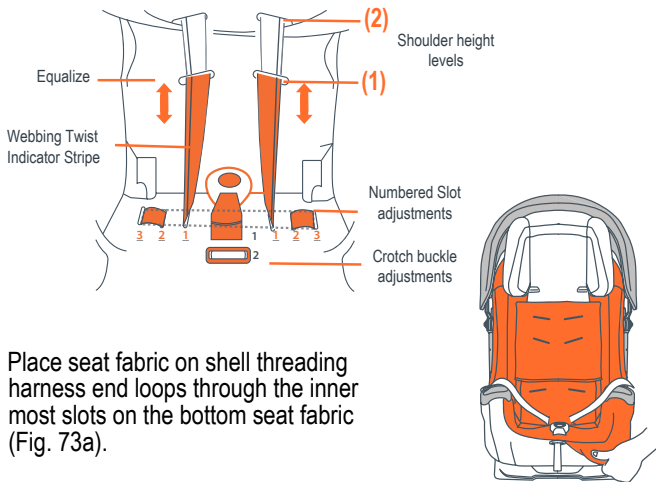


Fig. 73a

20. Place seat fabric on shell threading harness end loops through the inner most slots on the bottom seat fabric (Fig. 73a).
21. Thread buckle through the seat fabric.

5.0 Installation and Use Internal Harness Mode

5.26.4 Low Birth Weight Harness Shortening Routing Continued

22. Lower adjustable headrest to position 3 (lowest) (Fig. 74a).
NOTE: Adjusting to position 3 will align shoulder slots 1 and 2 in the seat fabric to shoulder position 1 and 2 in Car Seat back.
23. Install seat fabric body insert. Thread harness through inner slots on body insert seat bottom (Fig. 74b).
Seat fabric body insert use is not required.

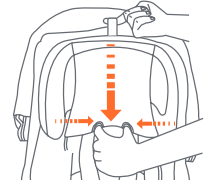


Fig. 74a



Fig. 74b

24. Insert buckle tongue into crotch buckle on child's left side (Fig. 74c).
25. Feed harness end loop from the back side of the buckle tongues (Fig. 74c).
26. Feed chest clip through harness end loops on child's left side.
27. Pull up on webbing end loops to ensure the webbing end loops are equalized.
28. If using harness slots 1 on shell the harness must be threaded to the shoulder slot of the seat fabric and body insert (Fig. 74d).

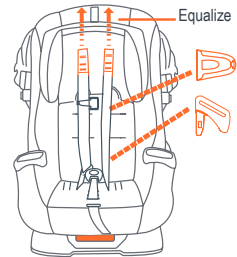


Fig. 74c

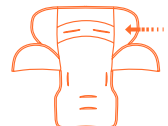


Fig. 74d

5.0 Installation and Use Internal Harness Mode

5.26.5 Low Birth Weight Harness Shortening Routing Continued

29. Thread harness end loops through appropriate slot No. 1 or 2. Shoulder slots must be at or below child's shoulder. Double check if the webbing twist indicator stripes are on the outer edges (Fig. 75a).
30. Thread loop A (inner most) through splitter plate and fold ends over to secure (Fig. 75b - Fig. 75c).
31. **DO NOT** use harness covers with Low Birth Weight Routing (Fig. 76b).
32. **DO NOT** use the head pillow with Low Birth Weight Routing (Fig. 76b).
33. Place child in seat and confirm harness is at or below child's shoulder.

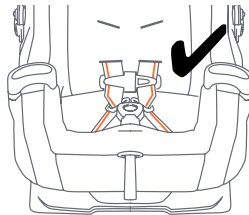
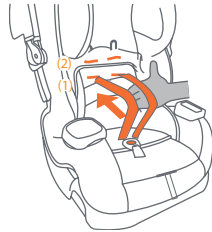


Fig. 75a

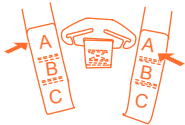


Fig. 75b

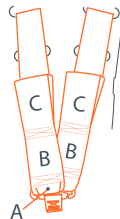


Fig. 75c

5.0 Installation and Use Internal Harness Mode

5.26.6 Low Birth Weight Harness Shortening Routing Continued

34. Visual (Fig. 76a), demonstrates the child in Car Seat with body insert, without head pillow and harness covers. **NEVER** use head pillow or harness covers in the Low BirthWeight Harness Routing.
NOTE: Store head pillow and harness covers in a dry, cool place.
35. Visual (Fig. 76b), demonstrates the child in Car Seat with body insert, head pillow and harness covers. **NEVER** use head pillow or harness covers in the Low Birth Weight Harness Routing.
NOTE: Store body insert, head pillow and harness covers in a dry, cool place.



Fig. 76a

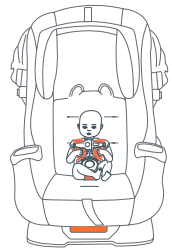


Fig. 76b

5.0 Installation and Use Internal Harness Mode

5.27 Pillow, Body insert and Harness Covers Use

1. Head Pillow Use

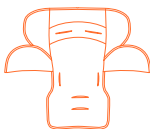
- Use is not mandatory.
- **DO NOT** use in the Low Birth Weight Harness Routing option.
- **DO NOT** use if child's head is pushed forward and falls down.
- **DO NOT** use Head pillow and Harness in same harness slot. **Discontinue use when the child requires use of harness position 3.**



Body Insert

2. Body Insert Use

- Use is not mandatory.
- **YOU MAY** use in the Low Birth Weight Harness Routing option.
- **ONLY** use the body insert with children who weigh between 4-18 lbs.
- Rear facing use only.



Body Insert

3. Harness Covers

- **DO NOT** use in the Low Birth Weight Harness Routing option.
- **Must** Be Used In All Other Harness Modes.



Harness Covers

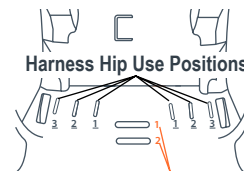
5.0 Installation and Use Internal Harness Mode

5.28 Harness Hip and Buckle Use Positions

Buckle Use Positions

- 1- Rear Facing and Forward facing use.
- 2- Rear Facing and Forward facing use.

NOTE: The Buckle should be at the crotch but not under.



Harness Hip Positions

- 1- Low Birth Weight Harness Shortening Routing Only.
- 2- All other uses.
- 3- Low Birth Weight Harness Shortening Routing Only.

5.0 Installation and Use Internal Harness Mode

5.29 Cup Holder Removal, Installation and Cleaning

Removal

- Press tab on bottom of cup holder to release cup holder and pull up to remove (Fig. 79a).

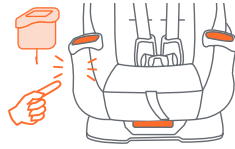


Fig. 75a

Installation

- Pull Car Seat cover back to expose cup holder receptacle (Fig. 79b).
- Align cup holder and press into place. Pull up on cup holder to ensure the cup holder is secured (Fig. 79c).
- Fit Car Seat cover over the front of the cup holder and fit the Car Seat cover over the cup holder (Fig. 79d).



Fig. 75b



Fig. 75c



Fig. 75d



Cleaning

- Wipe with mild solution of soap and water.
- Rinse with clean water.
- Never use “household” detergents or solvents.

5.0 Installation and Use Internal Harness Mode

5.30 Seat Fabric Removal And Laundering Seat Fabric Removal

1. Unfasten harness end loops from metal plate and pull harness through the seatback.
 - Unbuckle crotch buckle.
 - Unbuckle chest clip (Fig. 80a).
2. Headrest fabric Removal
 - Raise headrest to position 7
 - Pull up and out on seat fabric (Fig. 80b).
3. Main Pad
 - Lower headrest to position 5.
 - Pull up and out on seat fabric and feed harness, buckle tongues and chest clip through slots on seat fabric (Fig. 80c).
4. Slip seat fabric over cupholder (Fig. 80d).
5. To clean only use mild soap or detergent and warm water on a sponge or clean cloth.
 - **Do Not machine wash.**
 - **Do Not dry clean**
 - **Do Not bleach**
 - **Do Not iron.**



Fig. 80a

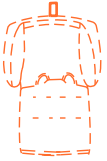


Fig. 80b

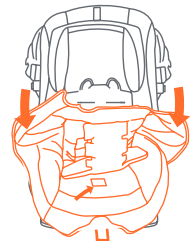


Fig. 80c



Fig. 80d

6.0 Installation and Use - Booster Mode

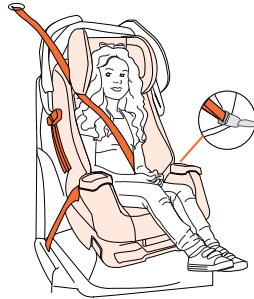
6.1 Booster Use Requirements

Parents are advised that children should use a child restraint with a built-in harness system until they exceed the weight or height limits specified by the manufacturer.

6.2 Weight and Height Requirements

This child restraint is designed for use by children whose:

- Age is 4 years or older, and
- Weight is between 40 and 100 lbs (18.1 and 45 kg), and
- Height is between 44 and 57 inches (112 and 145 cm).



6.3 Booster Seat Use

Child **MUST** meet all of these requirements to use this Booster Seat.

- **DO NOT** use this Booster Seat when top of child's ears are above the top edge of seat back. Severe head or neck injuries can result without proper head support.
- **DO NOT** use Booster Seat when the child's shoulders are above the shoulder belt guide with headrest in highest position (Fig. 81a).



Fig. 81a

6.0 Installation and Use - Booster Mode

6.4 Belt Position Booster Warnings

⚠ WARNING!
DEATH or SERIOUS INJURY can occur

- Use only with children who weigh between 40 and 100 pounds (18.1 and 45 kg) and whose height is between 44 and 57 inches (112 and 145 cm).
- Snugly adjust the vehicle lap and shoulder belt around your child according to the instructions in the vehicle owner's manual.
- Only the vehicle's lap and shoulder belt system when restraining the child in this booster seat as specified in the manufacturer's instructions.
- Secure this child restraint with a vehicle lap and shoulder belt.
- Follow all instructions on this child restraint and in the written instructions located in the pocket on the side of the seat.
- If instructions are missing, call 1-800-328-7363.
- Register your child restraint with the manufacturer.
- **NEVER** use this booster seat with only a vehicle lap belt (Fig. 82a).
- If child will not keep vehicle shoulder belt properly positioned on shoulder, **DO NOT** use this Booster Car Seat. Use a different child restraint system.
- **DO NOT** allow child to slide down in High-back Booster Car Seat which could position vehicle lap belt across child's abdomen and shoulder belt over neck or face.
- **DO NOT** use body insert or head pillow in Booster use mode.
- Secure this Booster Seat with the vehicle seat belt at all times (even when there is no child in it). An unsecured child restraint can injure someone if crash occurs.

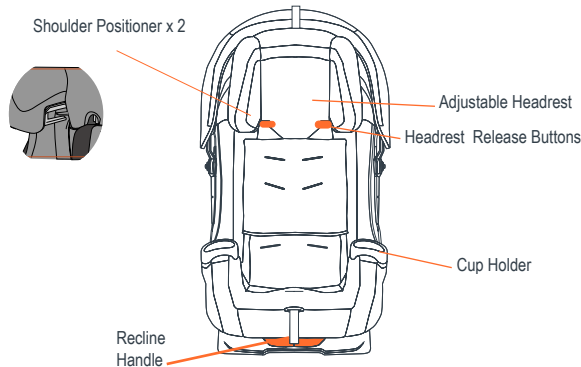
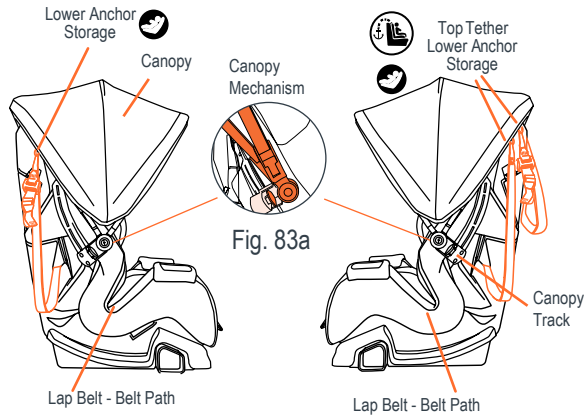


**NEVER USE
LAP BELT
ONLY!**

Fig. 82a

6.0 Installation and Use - Booster Mode

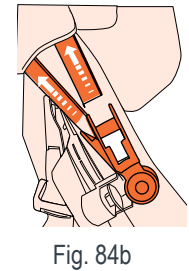
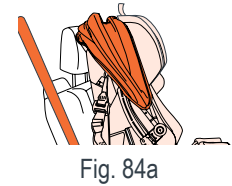
6.5 Booster Parts



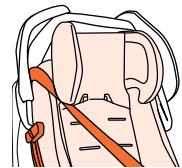
6.0 Installation and Use - Booster Mode

6.6 Preparing Canopy for use in Booster Car Seat Mode

1. The use of Canopy in Booster Car Seat mode is optional.
2. If Canopy will not be used, the Canopy can be stored at the top of the Booster Car Seat behind the adjustable headrest (Fig. 84a) or completely removed and stored for later use in a dry cool place.
3. After the Booster Car Seat has been placed in the appropriate seating position in the automobile, locate the canopy mechanism on the intended use, lap/shoulder belt use side (Fig 83a).
4. Temporarily remove both canopy hoops on the lap/shoulder side (Fig. 84b), and feed the shoulder belt through the shoulder belt positioner guide and replace the canopy hoops.



NOTE: The wider canopy hoop goes in the outer canopy receptacle and the narrower canopy hoop goes in the inner canopy receptacle.



6.0 Installation and Use - Booster Mode

6.7 Booster Car Seat Installation without Canopy Use

1. Remove harness and buckle from Car Seat. (See section 6.3 page 93) for removal of harness and buckle.
2. Adjust booster Car Seat to recline position 5. (See section 5.15 page 68) for base recline.

NOTE: The base recline must be in position 5 while in booster Car Seat mode. **NEVER** use rear-facing recline foot in booster Car Seat mode.

3. Place Booster Car Seat in an automobile seat with a Lap/Shoulder belt and does not have an active Frontal airbag. If the vehicle seat back is adjustable, adjust into the upright position or the position specified in the vehicle owner's manual for use with a Car Seat (Fig. 85a).

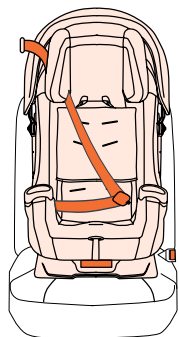


Fig. 85a

4. If Canopy will not be used in Booster Car Seat mode, lower adjustable headrest. Then rotate canopy to top of Booster Car Seat. After rotating canopy back to top of Car Seat raise Booster Car Seat and raise adjustable headrest to position 7. See section (5.11 Height Adjustment page 54) (Fig. 85b).

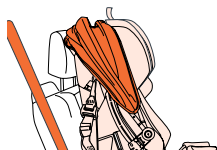
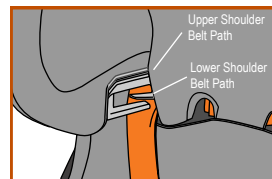


Fig. 85b

6.0 Installation and Use - Booster Mode

6.7.1 Booster Car Seat Installation without Canopy Use Continued

5. Thread shoulder belt into the lower slot of Booster Shoulder Belt Guide located on the underside of the Head Support.



- Slide shoulder belt into open end of slot, around Belt Retainer Tab and into Inner Slot of Head Support (Fig. 86a).

NOTE: Vehicle shoulder belt must slide freely in Booster Shoulder Belt Guide.

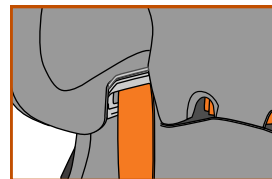


Fig. 86a

6. Place child in Booster Car Seat with child's back and rump contacting seating surfaces (Fig. 86b).



Fig. 86b

6.0 Installation and Use - Booster Mode

6.7.2 Booster Car Seat Installation without Canopy Use Continued

Alternative view for (Step 6) (Fig. 87a).

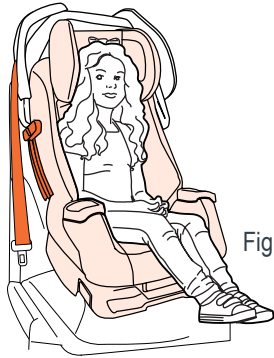


Fig. 87a

7. Pull the vehicle lap/shoulder belt across front of child and under both armrests. Buckle vehicle seat belt.

- Vehicle shoulder belt on buckle side must be under armrest.
- Position vehicle lap belt under armrests and low on hips, contacting top of thighs.
- Position vehicle shoulder belt across chest and shoulder (Fig. 87b).

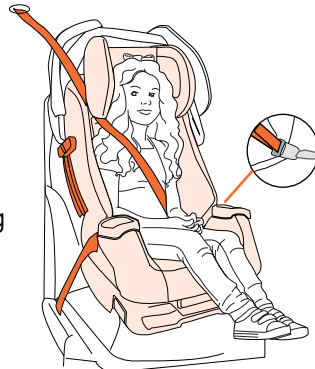
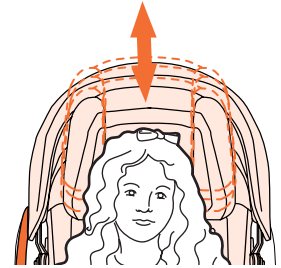


Fig. 87b

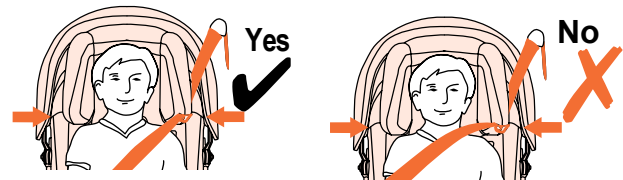
6.0 Installation and Use - Booster Mode

6.7.3 Booster Car Seat Installation without Canopy Use Continued

8. Adjust Head Support so that the vehicle shoulder belt passes over the shoulder midway between the neck and the end of the shoulder. The Booster Shoulder Belt Guide in the Head Support should be just above the child's shoulders.



9. Snugly adjust the vehicle lap/shoulder belt according to the instructions in the vehicle owner's manual. Vehicle lap belt must stay under both armrests.



6.0 Installation and Use - Booster Mode

6.8 Booster Car Seat Installation with Canopy Use

1. Remove harness and buckle from Car Seat. (See section 6.3 page 93) for removal of harness and buckle.
2. Adjust booster Car Seat to recline position 5. (See section 5.15 page 68) for base recline.

NOTE: The base recline must be in position 5 while in booster Car Seat mode. NEVER use rear-facing recline foot in booster Car Seat mode.

3. Place Booster Car Seat in an automobile seat with a Lap/Shoulder belt and does not have an active Frontal airbag. If the vehicle seat back is adjustable, adjust into the upright position or the position specified in the vehicle owner's manual for use with a Car Seat (Fig. 89a).
4. Locate the canopy mechanism on the intended lap/shoulder belt use side (Fig 89b).
5. Temporarily remove both canopy hoops on the lap/shoulder side (Fig. 89c) and feed the shoulder belt through the shoulder belt positioner guide and replace the canopy hoops. The shoulder belt webbing will be routed between the Booster Car Seat and the canopy (Fig. 89d).

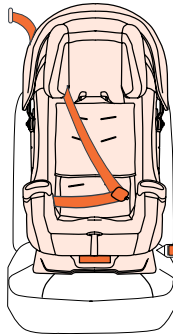


Fig. 89a

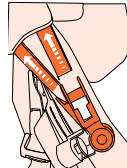


Fig. 89b

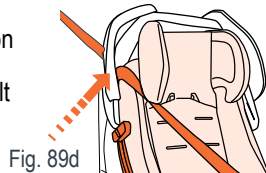


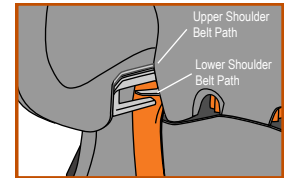
Fig. 89c

Fig. 89d

6.0 Installation and Use - Booster Mode

6.8.1 Booster Car Seat Installation with Canopy Use Continued

6. Thread shoulder belt into the lower slot of Booster Shoulder Belt Guide located on the underside of the Head Support.



- Slide shoulder belt into open end of slot, around Belt Retainer Tab and into Inner Slot of Head Support (Fig. 90a).
- NOTE:** Vehicle shoulder belt must slide freely in Booster Shoulder Belt Guide.

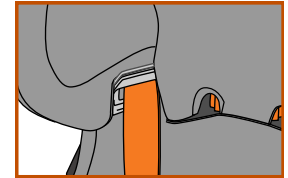


Fig. 90a

7. Place child in Booster Car Seat with child's back and rump contacting seating surfaces (Fig. 90b).

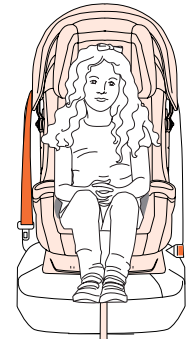


Fig. 90b

6.0 Installation and Use - Booster Mode

6.8.2 Booster Car Seat Installation with Canopy Use Continued

Alternative view for (Step 7) (Fig. 91a).

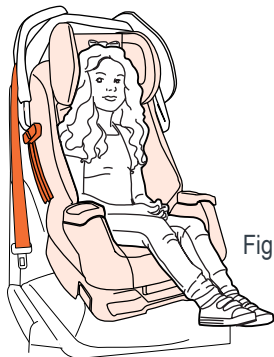


Fig. 91a

8. Pull the vehicle lap/shoulder belt across front of child and under both armrests. Buckle vehicle seat belt.

- Vehicle shoulder belt on buckle side must be under armrest.
- Position vehicle lap belt under armrests and low on hips, contacting top of thighs.
- Position vehicle shoulder belt across chest and shoulder (Fig. 91b).

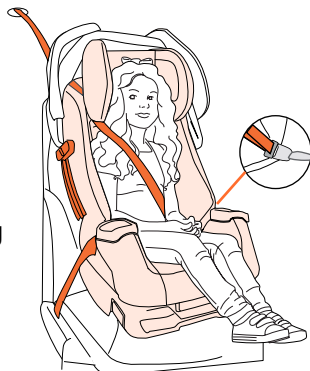
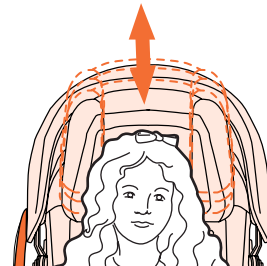


Fig. 91b

6.0 Installation and Use - Booster Mode

6.8.3 Booster Car Seat Installation with Canopy Use Continued

9. Adjust Head Support so that the vehicle shoulder belt passes over the shoulder midway between the neck and the end of the shoulder. The Booster Shoulder Belt Guide in the Head Support should be just above the child's shoulders.



10. Snugly adjust the vehicle lap/shoulder belt according to the instructions in the vehicle owner's manual. Vehicle lap belt must stay under both armrests.



6.0 Installation and Use - Booster Mode

6.9 Harness System Removal for Booster Car Seat Installation

1. Remove the harness loop ends from the splitter plate and pull harness through the seat back.

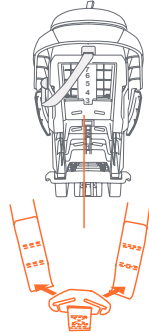
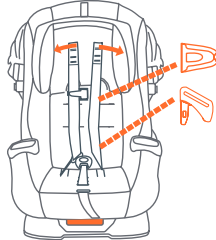


Fig. 93a

2. Remove head pillow and harness covers (Fig. 93b).



3. Remove chest clip and buckle tongue on child's left side and set aside (Fig. 93b).



6.0 Installation and Use - Booster Mode

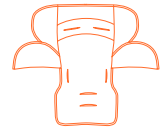
6.9.1 Harness System Removal for Booster Car Seat Installation Cont.

4. Leaving buckle tongue in buckle on child's right side, pull webbing from child left side to completely remove the harness system from Car Seat (Fig. 94a).



Fig. 94a

5. Remove body insert if being used (Fig. 94b).



Body Insert
Fig. 94b

6. Adjust seat to full recline position.
1. Locate buckle metal stamping and push through bottom of Car Seat. Pull buckle with metal stamping through Car Seat fabric.

7. Insert buckle tongue into child left side, thread webbing through buckle, chest clip and harness covers (Fig. 94c).

8. Store pillow, body insert, harness covers and harness assembly in dry cool area for future use.

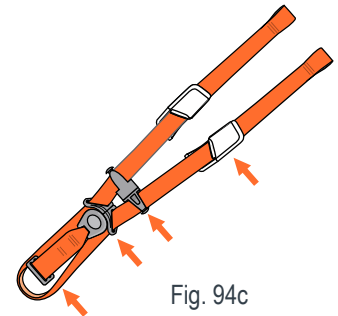


Fig. 94c

7.0 ADDITIONAL INFORMATION

Please Drive Safely

7.1 Certification

The Car Seat system conforms to all applicable Federal Motor Vehicle Safety Standards for use in motor vehicles.

TODDLER Car Seat (With Harness System)

This Restraint is Certified for Use in Motor Vehicles.

BOOSTER Car Seat (Without Harness System)

This Restraint is Certified for Use in Motor Vehicles.

7.2 Aircraft Use

TODDLER Car Seat (With Harness System)

This Restraint is Certified for Use in Aircraft.

BOOSTER Car Seat (Without Harness System)

This Restraint is NOT Certified for Use in Aircraft as a Booster Car Seat because aircrafts do not have shoulder belts.

7.3 Vehicle Seat Protection

Protect vehicle seat. Use a thin Car Seat mat, thin towel, or thin blanket under and behind the Car Seat.

7.0 ADDITIONAL INFORMATION

7.4 Instruction Manual Storage

Store this manual in the pocket provided on the side of the seat cover.

7.5 Car Seat Useful Life

DO NOT use this Car Seat in Harness Mode 7 years after the date on back seat.

DO NOT use this Car Seat in Booster Car Seat Mode 9 years after the date on back of seat.

Parts may be missing, damages, or the Car Seat may have been in a crash.

7.6 Replacement Parts

If You Need Help or Replacement Parts, please call our Customer Service Department at 1-800-328-7363 between the hours of 8:00 a.m. and 4:30 p.m., Standard Time, Monday through Friday or visit us online at www.babytrend.com

7.0 ADDITIONAL INFORMATION

7.7 Care and Cleaning

- Follow these instructions as needed for maintenance.

7.7.1 Removing The Seat Fabric, Body insert and Pillow

- Follow directions in section 5.30.

7.7.2 Cleaning The Seat Fabric, Body insert and Pillow

- To clean only use mild soap or detergent and warm water on a sponge or clean cloth.
- Do Not machine wash.
- Do Not dry clean
- Do Not bleach
- Do Not iron.

7.7.3 Cleaning Car Seat Parts and Buckles

- Wipe with mild solution of soap and water. Avoid wetting labels.
- Rinse with clean water.
- Never use “household” detergents or solvents.

8.0 Registration Information

REGISTER YOUR Car Seat

Please complete the following information. The model number and manufactured in (date) can be found on a label on the bottom of the Car Seat.

Model Number: _____

Manufactured in: _____

Purchase Date: _____

Please fill out the prepaid registration post card attached to the harness straps and mail it today.

Car Seats could be recalled for safety reasons. You must register the Car Seat to be reached in a recall. Send your name, address, e-mail address if available, and the Car Seat’s model number and manufacturing date to:

Baby Trend®, Inc, 13048 Valley Blvd. Fontana CA 92335 or call **1-800-328-7363** or register online at:

<https://babytrend.com/pages/car-seat-product-registration>

For recall information, call the **U.S. Government’s Vehicle Safety Hot line** at **1-888-327-4236** (TTY: 1-800-424-9153), or go to:

<https://www.nhtsa.gov>.

If You Need Help

Please contact our Customer Service Department with any questions concerning your Car Seat. When you contact us, please have the model and manufactured in (date) ready. The model number and manufactured in (date) can be found on a white label located on the bottom of the Car Seat.

USA Toll Free: **1-800-328-7363**

8:00 a.m. to 4:30 p.m. (PST) Monday - Friday

or www.babytrend.com

9.0 WARRANTY

WARRANTY

DO NOT RETURN YOUR PRODUCT TO THE STORE. PLEASE CONTACT BABY TREND® FOR REPLACEMENT PARTS, SERVICE AND REPAIR.

The Baby Trend® warranty covers workmanship defects within 1 year of purchase. Any product which has been subjected to misuse, abuse, abnormal use, excessive wear and tear, improper assembly, negligence, environmental exposure, alteration or accident, or has had its serial number altered or removed invalidates all claims against the manufacturer. Any damage to property during installation is the sole responsibility of the end user. Customer Service Department can be contacted at 1 (800) 328-7363 Monday through Friday between 8:00 a.m. and 4:30 p.m. (PST). Return Authorizations are required prior to returning product(s) to Baby Trend®.

Please visit <http://babytrend.com/pages/limited-warranty> for complete warranty details.

9.0 GARANTIA

GARANTIA

NO DEVUELVA SU PRODUCTO A LA TIENDA. POR FAVOR CONTACTE A BABY TREND® PARA PIEZAS DE REPUESTO, SERVICIO Y REPARACION.

La garantía de Baby Trend® cubre defectos de fábrica por 1 año después de la compra. Cualquier producto que haya sido sometido a uso inadecuado, abuso, uso anormal, desgaste excesivo, montaje incorrecto, negligencia, exposición ambiental, alteración o accidente, o cuyo número de serie haya sido alterado o removido, anula todos los reclamos contra el fabricante. Cualquier daño a la propiedad durante la instalación es la exclusiva responsabilidad del usuario final. El Departamento de Servicio al Cliente está disponible llamando al 1 (800) 328-7363, de lunes a viernes de 8:00 a. m. a 4:30 p. m. (PST). Se requiere una Autorización de Devolución antes de poder devolver el o los productos a Baby Trend®.

Visite <http://babytrend.com/pages/limited-warranty> para conocer todos los detalles de la garantía.

9.0 GARANTIE

GARANTIE

**NE PAS RETOURNER VOTRE PRODUIT AU MAGASIN.
VEUILLEZ CONTACTER BABY TREND® POUR DES
PIÈCES DE RECHANGE, ENTRETIEN ET RÉPARATION.**

La garantie Baby Trend® couvre les défauts de fabrication dans l'année qui suit l'achat. Tout produit ayant fait l'objet d'une mauvaise utilisation, d'un abus, d'une utilisation anormale, d'une usure excessive, d'un assemblage incorrect, d'une négligence, d'une exposition à l'environnement, d'une modification ou d'un accident, ou dont le numéro de série a été modifié ou retiré, annule toute réclamation contre le fabricant. Tout dommage matériel pendant l'installation est de la seule responsabilité de l'utilisateur final. Le service à la clientèle peut être contacté au 1 (800) 328-7363 du lundi au vendredi entre 8h00 et 16h30 (PST). Une autorisation de retour est requise avant de renvoyer le(s) produit(s) à Baby Trend®.

Veillez visiter <http://babytrend.com/pages/limited-warranty> pour obtenir tous les détails concernant la garantie.