

!WARNING

Carefully read and understand all instructions and warnings in this manual. Failure to properly use this Car Seat increases the risk of **SERIOUS INJURY** or **DEATH** in a sudden stop or crash.

KEEP INSTRUCTIONS FOR FUTURE USE.

Store this manual in the pocket provided on the side of the car seat base.

PROTECT 2-in-1 Folding Booster Seat

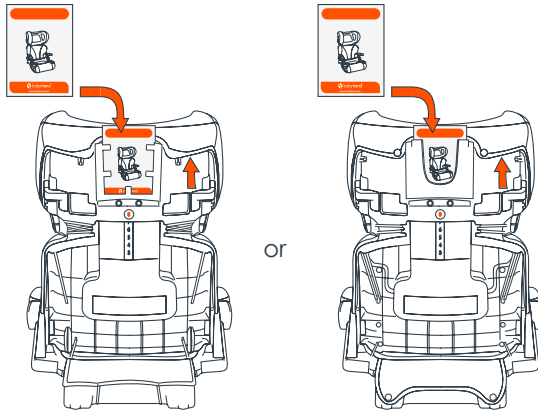

or

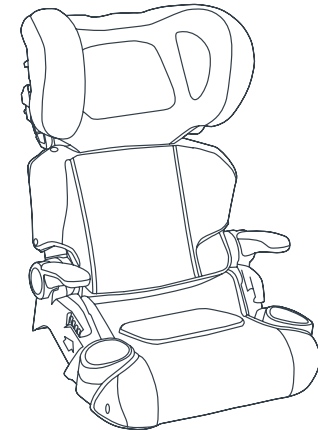

Set the head rest to the highest position to store the manual in the casing provided, or under the soft goods in backless mode.

OWNER'S MANUAL

Para instrucciones en Español, conéctese a www.babytrend.com o llamar al: 1-800-328-7363.

HB40-A

Baby Trend, Inc.
13048 Valley Blvd.
Fontana CA 92335

1-800-328-7363
(8:00 a.m. ~ 4:30 p.m. PST)
www.babytrend.com

 **babytrend**[®]
Quality • Comfort • Style

Table of Contents

1.0 General Warnings and Information	3
2.0 Use Recommendations	5
2.1 Weight and Height Recommendations	5
2.2 Booster Seat Use	6
3.0 Booster Seat Parts	7
3.1 High-Back Booster Car Seat	7
3.2 Backless Booster Car Seat	8
4.0 Weight and Height Recommendations	9
4.1 High-Back Booster Car Seat Use	9
4.2 Backless Booster Car Seat Use	10
5.0 Selecting a Vehicle Seating Location	11
5.1 Proper Use	11
5.2 Proper Installation	12
5.3 Vehicle Seats to Avoid	13
5.4 Vehicle Seat Belt Systems	13
5.5 Vehicle Seat Belt Systems to Avoid	14
6.0 Installation and Use	15
6.1 Proper Use	15
6.2 PROTECT 2-in-1 Folding Booster Seat Fit Guide	16
6.3 Installing Booster Seat	17
6.4 Securing Child in Booster Seat	18
6.5 Backless Booster Car Seat Installation and Use	20
6.6 Assembly and Removal For Back Support	24

Table of Contents

6.7 Booster Seat Back Angle	24
6.8 Headrest Adjustment	24
6.9 Cup Holder	25
6.10 Shoulder Belt Adjustment	25
6.11 Shoulder Belt Insertion	25
6.12 Booster Seat Storage	25
6.13 Use and Adjustment of Vehicle Shoulder Belt Positioner	26
7.0 Safety Checklist/Safe Practices	27
7.1 Safety Checklist	27
7.2 Safe Practices	28
8.0 Additional Information	29
8.1 Certification	29
8.2 Aircraft Use	29
8.3 Vehicle Seat Protection	29
8.4 Instruction Manual Storage	29
8.5 Booster Seat Useful Life	29
9.0 Registration Information	30
10.0 Care and Cleaning	31
10.1 Removing Seat Pad, Back Pad and Headrest Pad	31
10.2 Cleaning Seat Pad, Back Pad and Headrest Pad	31
10.3 Cleaning Shell	31
10.4 Reattach Seat Pad, Back Pad and Headrest Pad	31
10.5 Replacement Parts	31
11.0 Warranty	32

1.0 General Warnings and Information

WARNING!

DEATH or SERIOUS INJURY can occur:

- Failure to follow these instructions and Booster Seat labels can result in injury or death to a child from striking the vehicle's interior during a sudden stop or crash.
 - Even if the Booster Seat seems easy to figure out on your own, it is important to read these instructions and the vehicle owner's manual for details you might miss.
- The instructions in this manual and in your vehicle owner's manual must be followed carefully. If there is a conflict between the two, the vehicle owner's manual must be followed.
- Failure to use the automobile seat belt or to adjust it properly can result in your child striking the vehicle's interior during a sudden stop or crash. Serious injury or death can occur.
- **DO NOT** allow others (baby sitters, friends, grandparents, etc.) to use this Booster Seat unless they read and understand the instructions and labels.
- Only use accessories manufactured by Baby Trend®. Use of accessories can affect your child's safety in a sudden stop or crash.
- **DO NOT** modify or attach any toys, padding, or other items to this Booster Seat. Untested modifications or padding could result in injury in a crash.
- Secure this Booster Seat with the vehicle seat belt at all times (even when there is no child in it). An unsecured child restraint can injure someone if a crash occurs.

1.0 General Warnings and Information

- Direct sunlight can make Booster Seat surfaces hot enough to burn your child. Use caution and check them on hot, sunny days.
- **NEVER** leave child unattended.
- **DO NOT** use this Booster Seat if it has been in a crash. (There may be hidden damage and it must be replaced.) Your insurance company may provide some assistance replacing this booster.
- **DO NOT** use this Booster Seat if it is damaged in any way or has missing parts.
- Discontinue use of this booster seat after 9 years from the date of manufacture printed on the label on the bottom of the seat.
- Secure this child restraint with a vehicle lap and shoulder belt.

2.0 Use Recommendations

Parents are advised that children should use a child restraint with a built-in harness system until they exceed the weight or height limits specified by the manufacturer.

2.1 Weight and Height Requirements:

High-Back Booster

This child restraint is designed for use by children whose:

- Age is 4 years or older, and
- Weight is between 40 and 120 lbs (18.1 and 54.4 kg), and
- Height is between 44 and 57 inches (112 cm to 145 cm).

Backless Booster

This child restraint is designed for use by children whose:

- Age is 4 years or older, and
- Weight is between 40 and 120 lbs (18.1 and 54.4 kg), and
- Height is between 44 and 57 inches (112 cm to 145 cm).

Baby Trend recommends using a car seat with a built-in harness for as long as possible to the maximum weight before changing to a Booster car seat.

2.0 Use Recommendations

2.2 Booster Seat Use:

Child **MUST** meet all of these requirements to use this Booster Seat.

! WARNING!

DEATH or SERIOUS INJURY can occur:

- **DO NOT use this Booster Seat when top of child's ears are above the top edge of seat back. Severe head or neck injuries can result without proper head support.**
- **DO NOT use Booster Seat when the child's shoulders are above the shoulder belt guide with headrest in highest position (Fig. 6).**

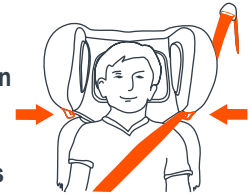
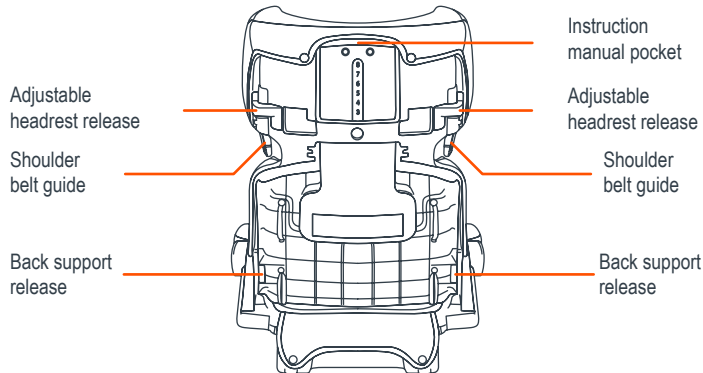
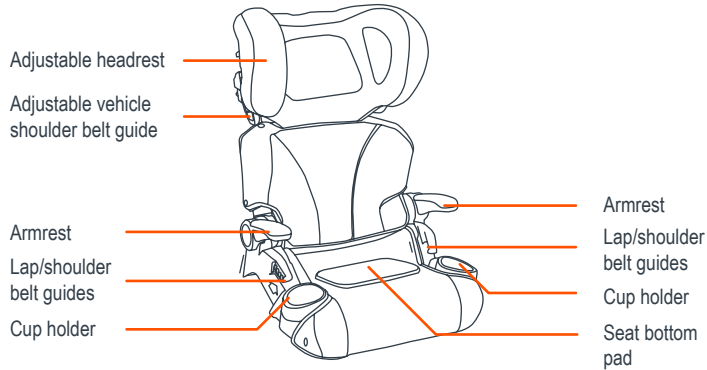

Fig. 6

3.0 Booster Seat Parts

3.1 High-Back Booster Car Seat



3.0 Booster Seat Parts

3.2 Backless Booster Car Seat (**WITHOUT** Back Support)

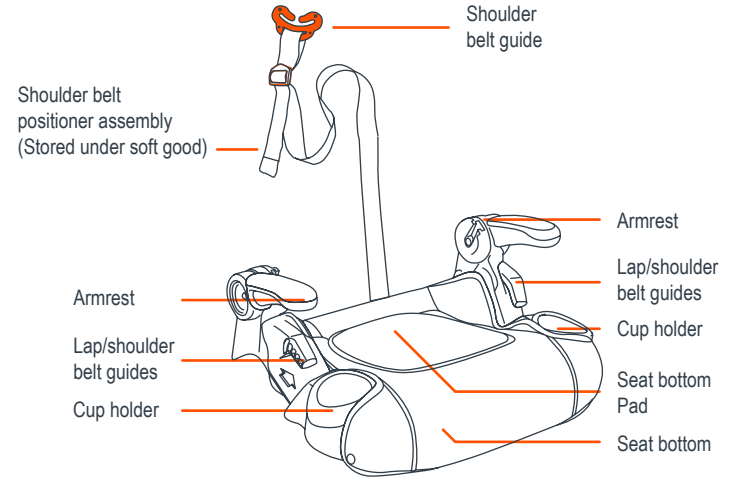

4.0 Weight and Height Recommendations

4.1 HIGH-BACK BOOSTER CAR SEAT USE



Child **MUST** meet all of the following requirements to use the High-back Booster Car Seat mode:

- Child's weight is between 40 and 120 lbs. (18.1 and 54.4 kg) **and**
- Child's height is between 44 and 57 in. (112 and 145 cm) **and**
- Child must be at least 4 years of age.



Baby Trend® and the American Academy of Pediatrics recommend using a High-back Booster Car Seat as long as possible before changing to a Backless Booster Car Seat. The High-back Booster Car Seat should be used until the child's shoulders do not fit comfortably under the side wings of the Head Support.

Parents are advised that the Back Support and Head Support of the High-back Booster Car Seat provide incremental crash protection in frontal and side impact crashes. Removing the Back Support and Head Support earlier than necessary also removes the incremental crash protection.

4.0 Weight and Height Recommendations

4.2 BACKLESS BOOSTER CAR SEAT USE



Child **MUST** meet all of the following requirements to use the Backless Booster Car Seat mode:

- Child's weight is between 40 and 120 lbs. (18.1 and 54.4 kg) **and**
- Child's height is between 44 and 57 in. (112 and 145 cm) **and**
- Top of child's ears must be below top of vehicle seat back or vehicle headrest **and**
- Child must be at least 4 years of age.



Baby Trend® and the American Academy of Pediatrics recommend using a Backless Booster Car Seat until the child reaches a standing height of 57 in. (145 cm) before changing to secure the child with a vehicle seat belt, without a booster car seat.

⚠️ WARNING!

DEATH or SERIOUS INJURY can occur:
• TO AVOID INJURIES FROM WHIPLASH, TOP OF CHILD'S EARS MUST BE BELOW TOP EDGE OF VEHICLE SEAT BACK OR VEHICLE HEADREST.



5.0 Selecting a Vehicle Seating Location

5.1 Proper Use:

⚠️ WARNING!

DEATH or SERIOUS INJURY can occur:

- Use only the vehicle's lap and shoulder belt system when restraining a child in this Booster Seat.
- NEVER use the Booster Seat with only a vehicle lap belt.
- DO NOT use this Booster Seat with vehicle seat belts mounted to front door.
- DO NOT use this Booster Seat if it cannot be properly installed. Some child restraints will not fit some vehicle seating positions.
- NEVER use this Booster Seat in any vehicle seating position equipped with an active air bag unless recommended by the vehicle manufacturer. For side air bags see page 8.
- DO NOT use this Booster Seat in rear seat of a compact pickup truck. Severe head injury or death can occur.

⚠️ WARNING



Never use this Car Seat in a vehicle seating location that has an Active Frontal Air Bag.

DEATH OR SERIOUS INJURY can occur. Please refer to the vehicle's owner's manual for additional information about Active Air Bags and child safety seat installation.

5.0 Selecting a Vehicle Seating Location

5.2 Proper Installation:

1. National Highway Traffic Safety Administration (NHTSA) alerts vehicle owners that, according to accident statistics, children under age 13 are safer when properly restrained in the rear seating positions rather than in front seating positions.
2. Refer to vehicle owner's manual for car seat installation instructions for your vehicle.
 - Use Booster Seat in a vehicle rear seat location whenever possible.
 - Never put Booster Seat in a front seat location unless recommended by vehicle owner's manual.
 - For vehicles with air bags, refer to vehicle owner's manual for child restraint installation information.
 - If a vehicle front seat location with an air bag must be used, follow the vehicle manufacturer's instructions for child restraint use and move the vehicle seat back as far as possible.

Baby Trend® Policy Statement

Use of PROtect Car Seat Series PROTECT 2-in-1 Folding Booster Seat Child Restraint in Conjunction with Side Air bags

To determine the types of side impact air bag(s) your vehicle may have for individual seating positions, please refer to your vehicle owner's manual.

The PROTECT 2-in-1 Folding Booster Seat child restraint may be used in any rear seating position equipped only with side impact air bags that are roof mounted with "curtain" type deployment. For all other vehicles with other types of side impact air bags, please refer to the specific vehicles owner's manual for appropriate use of child restraints, or call the automobile manufacturer for more information.

5.0 Selecting a Vehicle Seating Location

5.3 Vehicle Seats to Avoid:

DO NOT use this Booster Seat with the following vehicle seats:



Seats facing SIDES of vehicle



Seats facing REAR of vehicle



Rear seats of small extended cab pickup trucks

5.4 Vehicle Seat Belt Systems:

Use only the vehicle's lap and shoulder belt system when restraining the child in this booster seat.

Design and operation of vehicle seat belt systems vary from vehicle to vehicle and from seating location to seating location in the same vehicle. Not all vehicle seat belts can be used with a child restraint. Refer to the information on page 14 for information on the various types of vehicle seat belt systems.

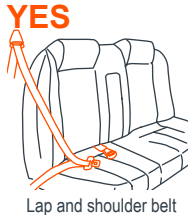

Lap and shoulder belt

5.0 Selecting a Vehicle Seating Location

5.5 Vehicle Seat Belt Systems to Avoid:

DO NOT use this Booster Seat with the following vehicle seat belts:



Lap belt only



Passive restraints with motorized shoulder belt

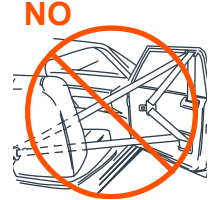

Passive restraints with lap or shoulder belts mounted on front door

WARNING

Secure this Booster Seat with the vehicle seat belt at all times (even when there is no child in it). An unsecured child restraint can injure someone if crash occurs.

6.0 Installation and Use

6.1 Proper Use:

⚠️ WARNING!
DEATH or SERIOUS INJURY can occur:

- Use only a vehicle lap and shoulder belt system when restraining the child in this Booster Seat.
- NEVER use just a lap belt (Fig. 15a). Always use a combination lap and shoulder belt (Fig. 15b).



Fig. 15a



Fig. 15b

- Snugly adjust the vehicle lap and shoulder belt around your child according to the instructions in the vehicle owner's manual.
- NEVER place the Booster Seat in a seating position with an active air bag unless recommended by the vehicle manufacturer.
- DO NOT allow child to slide down in Booster Seat. This could position the vehicle lap belt across your child's abdomen and the shoulder belt over your child's neck or face.

6.0 Installation and Use

6.2 PROTECT 2-in-1 Folding Booster Seat Fit Guide

Read all sections of this instruction booklet before use.

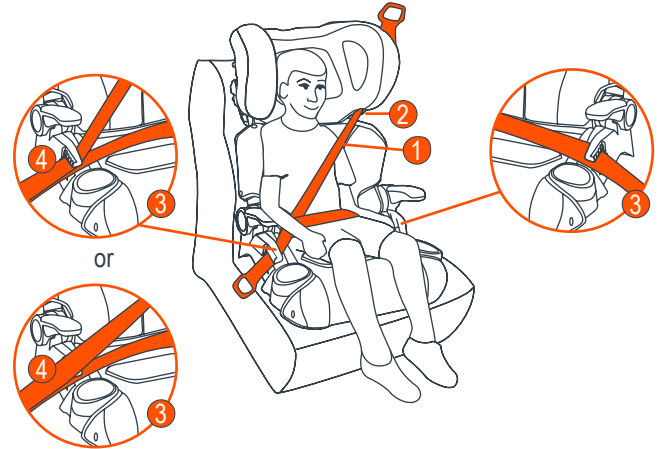

1. Shoulder Belt Centered on Shoulder
2. Belt Guide Shoulder Height
3. Lap Belt in Both Lap Belt Guides
4. Shoulder Belt Nearest Auto Buckle in Lap Belt Guide

6.0 Installation and Use

6.3 Installing Booster seat

PROTECT 2-in-1 Folding Booster Seat Fit Guide

1. Open the Booster Seat from its folded position (Fig. 17a):
 - Grasp seat back and seat bottom and pull to unfold Booster Seat.
 - Continue to move seat back until it reaches the upright use position (Fig. 17b).
2. Place Booster Seat in vehicle seating location selected.
 - Seating location **MUST** have a lap and shoulder belt (Fig. 17b).
 - If vehicle seat back is adjustable, adjust back into the upright position.
 - Adjust vehicle head rest to lowest position.

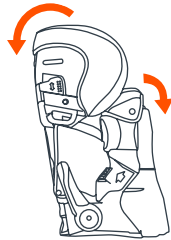

Fig. 17a

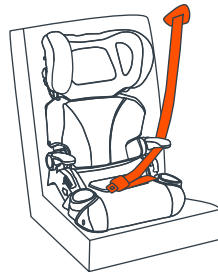

Fig. 17b

6.0 Installation and Use

6.4 Securing Child in Booster Seat

1. Secure child in booster seat.
 - Child **MUST** sit upright with back contacting seat back, **NOT** slouching or sliding down (Fig. 18a).
2. Adjust headrest so that the top of shoulder belt guides are at or just above child's shoulders (Fig. 18b).
 - Push headrest release handles in and move headrest up or down to desired position (Fig. 18c).
 - Release headrest handles and make sure handles are locked into position.
3. Adjust shoulder belt so that the inside edge of the shoulder belt is centered on shoulder (Fig. 18b).
 - Push release button to adjust belt guide after shoulder (Fig. 18d).

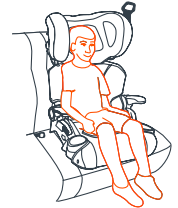

Fig. 18a

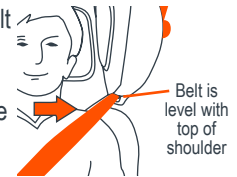

Fig. 18b

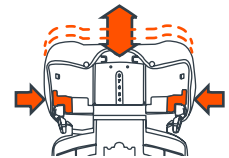

Fig. 18c

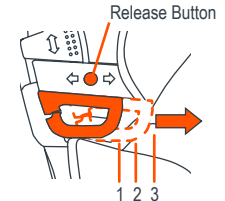

Fig. 18d

NOTE: If needed, the headrest can be re-adjusted up or down to ensure the seat belt is centered on child's the shoulder.

6.0 Installation and Use

- Place lap and shoulder belt across the front of child and buckle seat belt (Fig. 19a).

- Position lap belt under both lap belt guides (Fig. 19b).
- Place shoulder belt over child's chest and into shoulder belt guide and into lap belt guide closest to auto buckle (Fig. 19c).

NOTE: Armrest may be raised to make getting in Booster easier. Be sure to lower armrest once child is seated in booster seat.

- Snugly adjust lap and shoulder belt according to instructions in vehicle owner's manual.

- The **preferred** location for the shoulder belt is in the lap belt guide but to aid in a proper shoulder belt location the shoulder belt can be placed out of the lap belt guide but under the armrest (Fig. 19b).

- Check vehicle seat belt:

- Lap belt must be snug and low on hips contacting thighs.
- Shoulder belt must contact chest and be centered on shoulder.

NOTE: Some active children may change position or move seat belt.

- DO NOT** allow child to slide down under lap belt moving lap belt onto stomach or abdomen.
- DO NOT** allow child to place shoulder belt under arm or behind back.



Fig. 19a



Fig. 19b



Fig. 19c

6.0 Installation and Use

6.5 Backless Booster Car Seat Installation and Use

⚠️ WARNING!

DEATH or SERIOUS INJURY can occur:

- Child must be at least 4 years old and weigh at least 40 lbs. (18.1 kg) to use the Backless Booster Car Seat.

- Use High-back Booster mode as long as possible. The Back Support and Head Support provide incremental crash protection in frontal and side impact crashes. Removing the Back Support and Head Support earlier than necessary also removes the incremental crash protection.

- Vehicle lap/shoulder belt must be properly positioned on child. Use vehicle shoulder belt positioner to center vehicle shoulder belt on child's shoulders.

- Discontinue use of the Backless Booster Car Seat when the top of the child's ears are above top of the vehicle seat back or vehicle headrest.



6.0 Installation and Use

To secure car seat and your child:

1. Remove seat back support (see “Assembly and Removal for Back Support” section on page 24).
2. The Shoulder Belt Positioner will be affixed to the PROTECT 2-in-1 Folding Booster Seat and stored under the soft goods. Locate belt positioner; store under soft goods.
3. Place the car seat on the vehicle seat in a location equipped with a Lap/Shoulder Belt and centered between the Lap/Shoulder belt anchorages (see “Selecting a Vehicle Seating Locations” section).

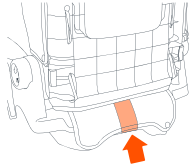

WARNING!

- Do not place the Backless Booster Car Seat in a seating position that has only a vehicle lap belt.



4. If the vehicle seat back is adjustable, adjust into the upright position or the position specified in the vehicle owner's manual for use with a car seat.



5. Place child in Backless Booster Car Seat with child's back and rump contacting seating surfaces.

6.0 Installation and Use

6. Place lap and shoulder belt across front of child and buckle seat belt.
 - Position lap belt under both lap belt guides.
 - Place shoulder belt over child's chest and into lap belt guide closest to auto buckle. (Fig. 22a).

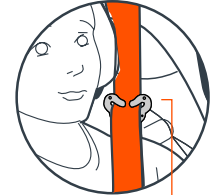
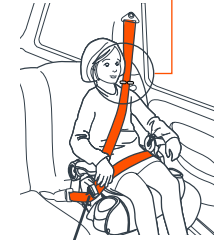

Fig. 22c

NOTE: For installations with children weighing more than 100 lbs. the Shoulder Belt **MUST** be placed out of the lap belt guide (Fig. 22b).

NOTE: Armrest may be raised to make getting in Booster easier. Be sure to lower armrest once child is seated in booster seat.

7. Place vehicle shoulder belt in Vehicle Shoulder Belt Positioner and adjust to position shoulder belt on child.
 - Thread vehicle shoulder belt through Vehicle Shoulder Strap Positioner as shown (Fig 22c).



See section 6.13 page 26 Shoulder Belt Positioner Use. Pull up or down on the webbing adjuster until the vehicle shoulder belt is centered over the child's shoulder.



Fig. 22a

Fig. 22b

- Check to be sure vehicle shoulder belt is properly positioned over shoulder and snug against child.

NOTE: Some vehicle shoulder belts with emergency locking retractors allow child to pull belt out and change position of belt. Use of Shoulder Belt Positioner helps maintain proper position of shoulder belt.

6.0 Installation and Use

8. Check the fit of the vehicle seat belts on the child:

- Vehicle lap belt must be low on hips contacting the thighs.
- Vehicle shoulder belt must contact the chest and be centered on the shoulder. Use the Shoulder Belt Positioner to adjust the position of the vehicle shoulder belt.
- **DO NOT** place vehicle shoulder belt under child's arm or behind child.



⚠️ WARNING!

- Discontinue use of Backless Booster when top of child's ears are above top edge of vehicle head rest and vehicle seat back.

To remove your child:

Unbuckle vehicle seat belt and remove your child.

6.0 Installation and Use

6.6 Assembly and Removal for Back Support

To Remove Back:

Press the two release buttons and lift.

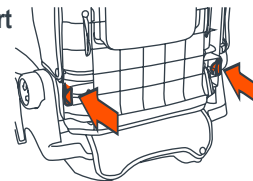

To Install:

Align tabs on booster seat back and slide into place. Pull up on back to ensure seat back is secured.

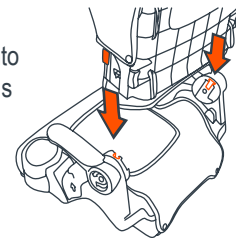

6.7 Booster Seat Back Angle

- The PROTECT 2-in-1 Folding Booster Seat has a range of motion to match your vehicle's seats back.

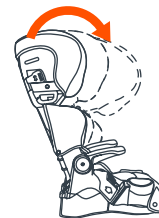

6.8 Headrest Adjustment

- Push headrest release handles in and move headrest up or down to desired position.

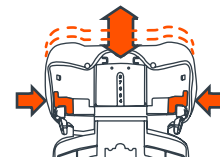

6.0 Installation and Use

6.9 Cup Holder

⚠ WARNING

AVOID INJURY! DO NOT place pencils or other sharp or pointed objects in cup holder.

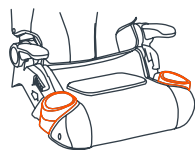

6.10 Shoulder Belt Adjustment

- Press release button to move shoulder belt guide to position 1, 2 or 3 (Fig. 25a).

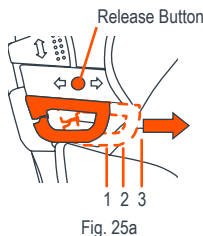

6.11 Shoulder Belt Insertion

- Press down on belt guide.
- Insert Shoulder Belt and release guide (Fig. 25b).

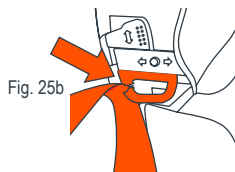

6.12 Booster Seat Storage:

To Fold Booster Seat:

- Fold the seat back forward towards the seat bottom.
- Move seat back down until it is in the folded position (Fig. 25c).
- Store Booster Seat inside carton, in a cool dry location.

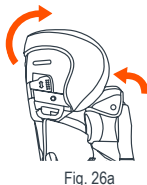

6.0 Installation and Use

6.13 Use and Adjustment of Vehicle Shoulder Belt Positioner

- Use the Shoulder Belt Guide, only if necessary to center the vehicle Shoulder Belt on the child's shoulder. Shoulder Belt should be centered on child's shoulder as shown (Fig. 26a). Shoulder Belt Guide is stored under the seat pad.

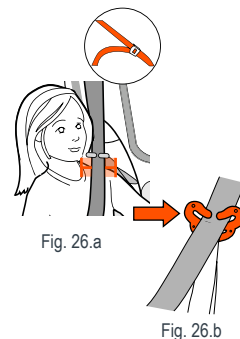

- Insert the vehicle shoulder belt into both sides of the Shoulder Belt Guide (Fig. 26b). Pull the free end of the Shoulder Belt Guide strap down (Fig. 26c) to bring the shoulder belt into the proper centered shoulder position (Fig. 25a).

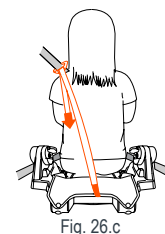

- Do Not over tighten the Shoulder Belt Guide that forces the Shoulder Belt into an unnatural transition over the child's shoulder (Fig. 25d). The Shoulder Belt should have smooth transition over the shoulder (Fig. 26e).

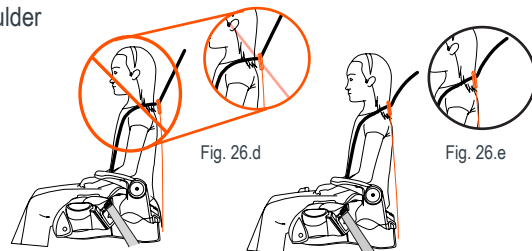

7.0 Safety

7.1 Safety Checklist:

- ✓ Did you read and understand these instructions and labels on the Booster Seat?
- ✓ Is the child the proper weight and height for the Booster Seat?
- ✓ Is the child secured in the rear seat?
- ✓ Is the child restraint forward-facing with a lap and shoulder belt?
- ✓ Is the vehicle seat belt properly secured and snugly adjusted?
 - Lap belt in both lap belt guides?
 - Shoulder belt in shoulder belt guide and lap belt guide?
 - Shoulder belt guide at or above child's shoulders?
 - Child is sitting up with lap belt low and contacting thighs?
 - Shoulder belt is contacting chest and centered on shoulder?
- ✓ Check for hot surfaces in sunny weather?
- ✓ Discontinue use of this booster Seat after 9 years from the date of manufacture printed on the label on the bottom of the seat.

Please Drive Safely

7.0 Safety

7.2 Safe Practices

For assistance with installation or use, contact one of the following sources:

- Baby Trend® at: Phone: 1-800-328-7363. Email: www.babytrend.com
- A certified Child Passenger Safety (CPST) Technician in your area. To locate a CPST Technician in your area, log onto www.nhtsa.dot.gov and select "Child Passenger Safety" and then select "Technician Contact Locator". Or attend a car seat check-up event. For car seat check-up event location and timing:
 - Log onto www.nhtsa.dot.gov and select "Child Seat Inspections".
 - Log onto www.seatcheck.org.
 - Call 1-866-SEAT CHECK (1-866-732-8243).

EVERYONE rides buckled up or the vehicle DOES NOT GO! Make NO EXCEPTIONS for adults or children!

- If someone unbuckles, the vehicle **STOPS!** Being firm and consistent will result in fewer discipline problems as children grow older. An unrestrained person can be thrown into and injure other passengers.
- **NEVER** try to tend to a crying child's needs while driving. Never take a child out of a child restraint for comforting while the vehicle is moving.

DO NOT allow child to slide down under lap belt or put shoulder belt under arm or behind back.

DO NOT allow a child to have lollipops, popsicles, or other food on a stick. The items can injure the child in a sudden stop or crash.

Put heavy or sharp items in the trunk. Loose items can be deadly in a crash.

If you need to use a blanket in cold weather, put the child in the restraint and cover both with the blanket.

8.0 Additional Information

8.1 Certification:

This child restraint system conforms to all applicable Federal Motor Vehicle Safety Standards for use in motor vehicles.

This Booster Seat is certified for use in motor vehicles.

8.2 Aircraft Use:

This restraint is **NOT** Certified for Aircraft Use. An aircraft does not have a combination lap and shoulder belt required to use this Booster Seat.

8.3 Vehicle Seat Protection:

Protect vehicle seat. Use a thin car seat mat, thin towel, or thin blanket under and behind Booster Seat.

8.4 Instruction Manual Storage:

Store instruction manual in the pocket on back of Booster Seat or under soft goods in backless mode.

8.5 Booster Seat Useful Life:

Discontinue use of this booster Seat after 9 years from the date of manufacture printed on the label on the bottom of the seat.

Parts may be missing, damaged, or the Booster Seat may have been in a crash.

9.0 Registration Information

REGISTER YOUR CAR SEAT

Please complete the following information. The model number and manufactured in (date) can be found on a label on the bottom of the Car Seat.

Model Number: _____

Manufactured In: _____

Purchase Date: _____

Please fill out the prepaid registration post card attached to the harness straps and mail it today.

Child restraints could be recalled for safety reasons. You must register this restraint to be reached in a recall. Send your name, address, e-mail address if available, and the restraint's model number and manufacturing date to:

Baby Trend®, Inc, 13048 Valley Blvd. Fontana CA 92335 or call **1-800-328-7363** or register online at:

<https://babytrend.com/pages/car-seat-product-registration>
For recall information, call the **U.S. Government's Vehicle Safety Hot line at 1-888-327-4236** (TTY: 1-800-424-9153), or go to <http://www.NHTSA.gov>.

If You Need Help

Please contact our Customer Service Department with any questions concerning your child restraint. When you contact us, please have the model and manufactured in (date) ready. The model number and manufactured in (date) can be found on a white label located on the bottom of the car seat.

USA Toll Free: **1-800-328-7363**

8:00 a.m. to 4:30 p.m. (PST) Monday - Friday

or **www.babytrend.com**

10.0 Care and Cleaning

10.1 Removing Seat Pad, Back Pad and Headrest Pad:

- Gently unhook elastic and (or) snaps. Remove pads from Booster Seat.

10.2 Cleaning Seat Pad, Back Pad and Headrest Pad:

- Hand wash in cool water with mild soap.
- Air dry.

10.3 Cleaning Shell:

- Wipe with mild solution of soap and water. Avoid wetting labels.
- Rinse with clean water.
- Never use “household” detergents or solvents.

10.4 Reattach Seat Pad, Back Pad and Headrest Pad:

- Place pads on Booster Seat, re-secure elastic and (or) snaps.

10.5 Replacement Parts

If You Need Help or Replacement Parts, please call our Customer Service Department at 1-800-328-7363 between the hours of 8:00 a.m. and 4:30 p.m. Pacific Standard Time, Monday through Friday or visit us online at www.babytrend.com

11.0 Warranty

WARRANTY

DO NOT RETURN YOUR PRODUCT TO THE STORE. PLEASE CONTACT BABY TREND® FOR REPLACEMENT PARTS, SERVICE AND REPAIR.

The Baby Trend® warranty covers workmanship defects within 1 year of purchase. Any product which has been subjected to misuse, abuse, abnormal use, excessive wear and tear, improper assembly, negligence, environmental exposure, alteration or accident, or has had its serial number altered or removed invalidates all claims against the manufacturer. Any damage to property during installation is the sole responsibility of the end user. Customer Service Department can be contacted at 1 (800) 328-7363 Monday through Friday between 8:00 a.m. and 4:30 p.m. (PST). Return Authorizations are required prior to returning product(s) to Baby Trend®. Please visit <http://babytrend.com/pages/limited-warranty> for complete warranty details.

11.0 Warranty

GARANTIA

NO DEVUELVA SU PRODUCTO A LA TIENDA. POR FAVOR CONTACTE A BABY TREND® PARA PIEZAS DE REPUESTO, SERVICIO Y REPARACION.

La garantía de Baby Trend® cubre defectos de fábrica por 1 año después de la compra. Cualquier producto que haya sido sometido a uso inadecuado, abuso, uso anormal, desgaste excesivo, montaje incorrecto, negligencia, exposición ambiental, alteración o accidente, o cuyo número de serie haya sido alterado o removido, anula todos los reclamos contra el fabricante.

Cualquier daño a la propiedad durante la instalación es la exclusiva responsabilidad del usuario final. El Departamento de Servicio al Cliente está disponible llamando al 1 (800) 328-7363, de lunes a viernes de 8:00 a. m. a 4:30 p. m. (PST). Se requiere una Autorización de Devolución antes de poder devolver el o los productos a Baby Trend®. Visite <http://babytrend.com/pages/limited-warranty> para conocer todos los detalles de la garantía.

11.0 Warranty

GARANTIE

NE PAS RETOURNER VOTRE PRODUIT AU MAGASIN. VEUILLEZ CONTACTER BABY TREND® POUR DES PIÈCES DE RECHANGE, ENTRETIEN ET RÉPARATION.

La garantie Baby Trend® couvre les défauts de fabrication dans l'année qui suit l'achat. Tout produit ayant fait l'objet d'une mauvaise utilisation, d'un abus, d'une utilisation anormale, d'une usure excessive, d'un assemblage incorrect, d'une négligence, d'une exposition à l'environnement, d'une modification ou d'un accident, ou dont le numéro de série a été modifié ou retiré, annule toute réclamation contre le fabricant. Tout dommage matériel pendant l'installation est de la seule responsabilité de l'utilisateur final. Le service à la clientèle peut être contacté au 1 (800) 328-7363 du lundi au vendredi entre 8h00 et 16h30 (PST).

Une autorisation de retour est requise avant de renvoyer le(s) produit(s) à Baby Trend®. Veuillez visiter <http://babytrend.com/pages/limited-warranty> pour obtenir tous les détails concernant la garantie.