

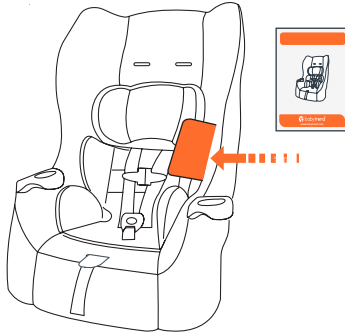
! WARNING

Carefully read and understand all instructions and warnings in this manual. Failure to properly use this Car Seat increases the risk of **SERIOUS INJURY** or **DEATH** in a sudden stop or crash.

KEEP INSTRUCTIONS FOR FUTURE USE.

Store this manual in the pocket provided on the underside of the seat cover. See back cover for location.

Trooper™ Convertible Car Seat



Store this manual in the pocket provided on the underside of the seat cover as illustrated above.



Scan QR Code for Trooper™ how to videos

OWNER'S MANUAL

For instructions in French, log on to www.babytrend.com or call: 1-800-328-7363.

VC01

Baby Trend, Inc.
13048 Valley Blvd.
Fontana CA 92335

1-800-328-7363
(8:00 a.m. ~ 4:30 p.m. PST)
www.babytrend.com



Quality • Comfort • Style

Table of Contents

1.0 General Warnings and Information	3
2.0 Use Recommendations	5
2.1 Rear facing seat requirements.....	5
2.2 Forward facing seat requirements.....	6
3.0 Car Seat Parts	7
4.0 Selecting a Vehicle Seating Location	9
4.1 Overall Considerations In Selecting A Location.....	9
4.2 Proper Use And Requirements.....	11
4.3 Safe Vehicle Seat Belt Systems.....	12
4.4 Locking Clip Installation	15
4.5 Unsafe Vehicle Seat Belt Systems.....	16
4.6 Preparation for Installation in Vehicle.....	18
4.7 Installation with UAS	19
4.8 UAS - Top Tether Anchor Locations	20
5.0 Installation and Use	21
5.1 Child Placement In Car Seat.....	22
5.1.1 Installation Diagrams.....	23
5.2 Rear Facing Installation with Lap/shoulder Belt.....	24
5.3 Rear Facing Installation with Lap Belt.....	26
5.4 UAS - Rear Facing Installation with UAS Lower Connector	28
5.5 Forward Facing Installation with Lap/Shoulder Belt and Top Tether	30
5.6 Forward Facing Installation with Lap Belt and Top Tether.....	32
5.7 Forward Facing Installation with UAS Lower Connector and Top Tether	34
5.8 Aircraft Installation.....	35
5.9 Child Placement In The Car Seat.....	36
5.10 Shoulder Harness Height Adjustment.....	38
5.11 Crotch Buckle Adjustment.....	39

Table of Contents

5.12 Seat Fabric Removal and laundering.....	40
5.13 Low Birth Weight Harness Shortening Routing.....	41
5.14 Pillow, Seat Insert and Harness Covers Use.....	45
5.15 Harness Hip and Buckle Use Positions.....	45
5.16 Cup Holder Removal Installation and Cleaning	47
5.17 Securing The Pillow	48
5.18 Pool Noodle/Rolled Towel Elevation	48
5.19 UAS Lower Anchor or Top Tether Removal.....	49
6.0 Safety Checklist/Safe Practices	49
6.1 Safety Checklist	49
7.0 Additional Information	50
7.1 Certification.....	50
7.2 Aircraft Use	50
7.3 Vehicle Seat Protection.....	50
7.4 Instruction Manual Storage	50
7.5 Car Seat Useful Life.....	50
8.0 Registration Information	51
9.0 Care and Cleaning	52
9.1 Removing The Seat Fabric, Seat Insert and Pillow.....	52
9.2 Cleaning The Seat Fabric, Seat Insert and Pillow.....	52
9.3 Cleaning Seat Parts and Buckles.....	52
9.4 Replacement Parts.....	52
10.0 Warranty	53



Scan QR Code for Baby Trend®
Trooper™ how to videos.

1.0 General Warnings and Information

WARNING!

DEATH or SERIOUS INJURY can occur:

- Failure to follow these instructions and car seat labels can result in injury or death to a child from striking the vehicle's interior during a sudden stop or crash.
- Follow all instructions on the child restraint and in the written instructions.
- Even if the car seat seems easy to use on your own, it is important to read these instructions and the vehicle owner's manual for details you might miss.
- The instructions in this manual and in your vehicle owner's manual must be followed carefully. If there is a conflict between the two, the vehicle owner's manual must be followed if it relates to the vehicle's seat belt, **UAS** or airbags.
- Failure to use the vehicle seat belt or to adjust it properly can result in your child striking the vehicle's interior during a sudden stop or crash. Serious injury or death can occur.
- **DO NOT** allow others (babysitters, friends, grandparents, etc.). To use this car seat unless they read and understand the instructions and labels and can demonstrate proper use to your satisfaction.
- Use only car seat accessories manufactured by Baby Trend®. Accessories can affect your child's safety in a sudden stop or crash.
- **DO NOT** modify or attach any toys, seat fabric, or other items to this car seat. Untested modifications could result in injury in a crash.

1.0 General Warnings and Information

- Secure this car seat with the vehicle seat belt or **UAS** Lower anchor connectors at all times (even when there is no child in it). An unsecured car seat can injure others if a crash occurs.
- Direct sunlight can make car seat surfaces hot enough to burn your child. Use caution and check the vehicle and car seat on hot, sunny days.
- **NEVER** leave child unattended under any circumstance.
- **DO NOT** use this car seat if it has been in a crash. (There may be hidden damage and it must be replaced). Your insurance company may provide some assistance replacing this car seat.
- **DO NOT** use this car seat if it is damaged in any way or has missing parts.
- **STOP USING THIS** car seat **AND PROPERLY DISPOSE** after the date on the back of the seat. **PROPERLY DISPOSE** in a dark trash bag. **DO NOT** sell to a thrift or consignment shop, at garage sales or flea markets.
- **NEVER** use this car seat in the home, on boats, in a motor home with side facing seat, low speed vehicles, golf carts, all terrain or other non certified uses. Only use the car seat in passenger cars, multipurpose vehicles, buses with qualifying anchorages or belt systems, school buses that have vehicle lap/shoulder belts and Aircraft.
- **ONLY** use this car seat in forward facing seats.
- **NEVER** use this car seat in any vehicle seating position equipped with an active air bag. Read your vehicle's owners manual to see how to turn off your airbag if you have no back seat or a child must ride in the front seat. For side airbags see section 4.1 (Page 11).

2.0 Use Recommendations

The American Academy of Pediatrics and Baby Trend recommend children remain in a rear-facing car seat for as long as possible, until they reach the highest weight or height allowed by their seat.

2.1 Rear facing seat requirements

Weight and Height Requirements:

- The car seat, in a rear facing position (Fig. 5a) is designed for use by children whose:
 - Weight is between 1.81 and 18 kg, (4 and 40 lbs) and
 - Height is 102 cm (40 in) or less
 - Top of head has **NOT** reached 25.4 mm (1" inch) from top of seatback (Fig. 5b).

Child **MUST** meet **ALL** of these requirements to use this car seat rear facing.

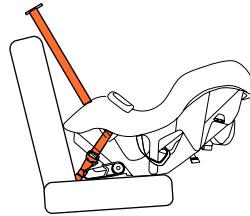
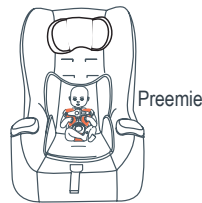


Fig. 5a



25.4 mm (1in.)

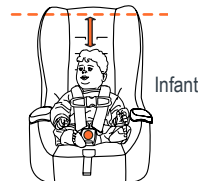


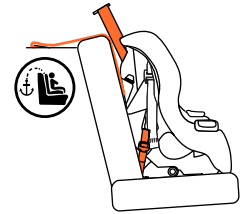
Fig. 5b

2.0 Use Recommendations

2.2 Forward facing seat requirements

Weight and Height Requirements:

- This car seat, installed in a forward facing position, is designed for use by children whose:
 - Weight is between 10.43 kg and 29 kg (23 and 65 lbs), and
 - Height is 127cm (50 inches) or less.
 - Age is 1 year old.
 - The top of the child's ears must be at or below the top of the car seat (Fig. 6a).
- Child **MUST** meet **ALL** of these requirements to use the car seat forward facing.

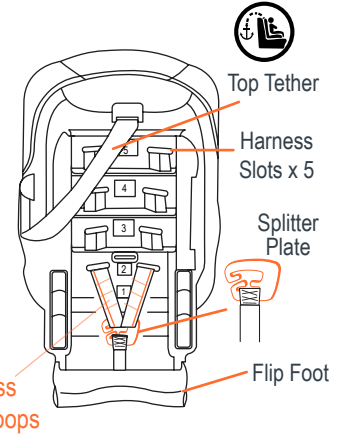
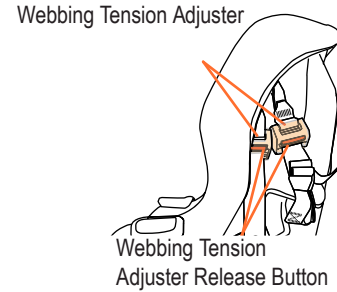
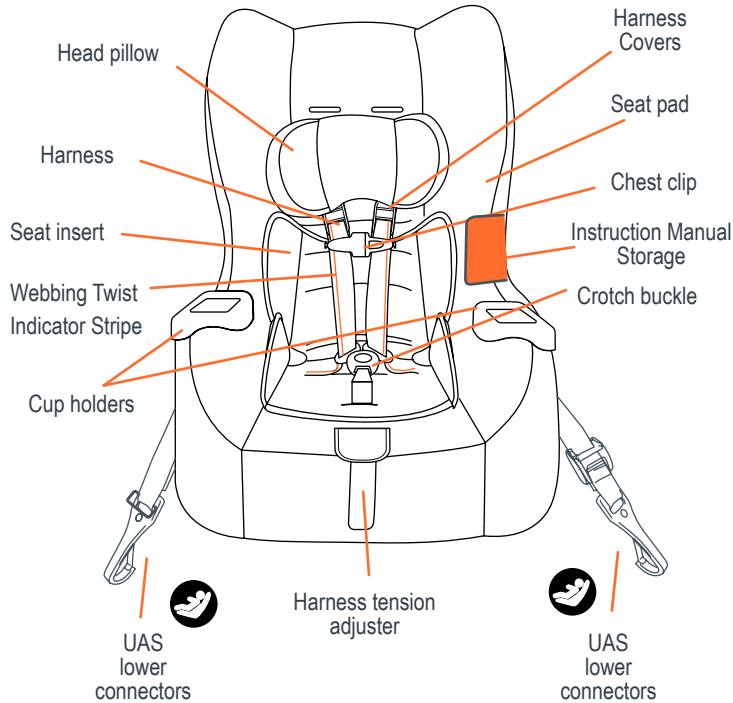


Top Ears Max Height

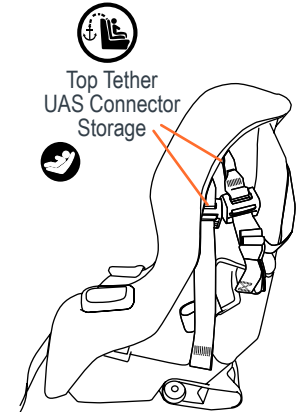
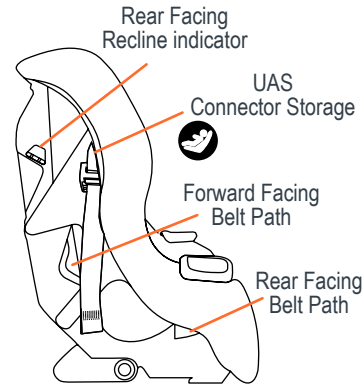


Fig. 6a

3.0 Car Seat Parts



Harness End Loops



4.0 Selecting a Vehicle Seating Location

! WARNING!

DEATH or SERIOUS INJURY can occur:

- IMPROPER PLACEMENT OF THE CAR SEAT INCREASES THE RISK OF SERIOUS INJURY OR DEATH.

! WARNING!

- Not every location within an vehicle may be safe for the installation of this car seat. Car seat must be tightly secured and remain tightly secured at all time. Some vehicles have no seating position installation of a car seat. Improper placement or use of a car seat that is not tightly secured in a vehicle will increase the risk of death or serious injury.
- Please follow the instructions in this manual and in your vehicle owner's manual carefully to ensure proper location and installation of the car seat. If you are uncertain about the proper location of the car seat within the vehicle, contact your vehicle manufacturer directly or through their dealer before using the car seat. You are also invited to call Baby Trend at 1-800-328-7363 for additional information or assistance.

4.1 Overall Considerations in Selecting a Location

- According to accident statistics, children are safer when properly restrained in rear vehicle seating positions, rather than front seating positions.

4.0 Selecting a Vehicle Seating Location

Whenever possible, this car seat should be secured in the rear center, seating position. The rear seat directly behind the front seats NOT in a third row rear seat (Fig. 10a).



Fig. 10a

- ONLY place in a forward-facing vehicle seat. DO NOT place this car seat in any vehicle seat that faces to the rear (Fig. 10b).
- DO NOT place this car seat in any vehicle seat that faces to either side of the vehicle (Fig. 10c).



Fig. 10b

- We recommend that you use the center rear seat position as the safest location for the car seat. In addition, whenever possible, have an adult ride in the rear with the child in order to monitor the child.



Fig. 10c

NOTE: UAS system may not be available in the center rear seat position. Install with a vehicle seat belt if UAS is not available.

- If the driver is the only adult in the vehicle and the child requires constant monitoring, then a vehicle front seating position may be used if there is no passenger side Active Frontal Air bag and all of the following requirements are met for this location.

4.0 Selecting a Vehicle Seating Location

4.2 Check that the Vehicle Seat Meets the Following Requirements

! WARNING!



DO NOT place rear-facing child seat on front seat with active frontal air bag. DEATH OR SERIOUS INJURY can occur. The back seat is the safest place for children 12 and under.

- **NEVER** place this car seat in a vehicle seating location that has an Active Frontal Air Bag! Active Air Bags inflate with great force! An inflating Air Bag can strike a car seat with enough force to cause death or serious injury to your child. If your vehicle is equipped with a front passenger side active air bag, please refer to the vehicle's owner's manual for additional information about active air bags and child car seat installation.



Forward-Facing



Rear-Facing

- **DO NOT** use this car seat in a vehicle that has a vehicle seatback that does not lock into place. A seatback that folds forward must have a latch or locking mechanism to prevent it from flying forward and striking the child in a sudden stop or accident.

4.0 Selecting a Vehicle Seating Location

- Please review your vehicle owner's manual to determine the best location for the car seat or to determine if any locations are unsafe for car seat installation. If you do not have the vehicle owner's manual or the owner's manual does not address child car seat installation, please contact the vehicle manufacturer to obtain this information before using this car seat.

VEHICLE SEAT BELT REQUIREMENTS

! WARNING!

DEATH or SERIOUS INJURY can occur:

- **THE CAR SEAT MUST BE TIGHTLY SECURED BY THE VEHICLE SEAT BELT AT ALL TIMES. A VARIETY OF VEHICLE SEAT BELT SYSTEMS ARE AVAILABLE IN VEHICLES. SOME OF THESE VEHICLE SEAT BELT SYSTEMS ARE NOT SAFE FOR USE WITH THE CAR SEAT.**

Even newer vehicles can have seat belts systems that are NOT safe for use with the car seat. These systems may look safe but their method of operation precludes their use with the car seat. If you are unsure if the vehicle seat belt is safe for use with the car seat, check the vehicle owner's manual or contact the vehicle manufacturer, or your vehicle dealer for additional information.

4.3 SAFE Vehicle Seat Belt Systems

The following vehicle seat belt systems **CAN BE USED** with the car seat provided that all of the other requirements prescribed in these instructions, including seat position, secure installation and all instructions provided by your vehicle owner's manual, are followed.

4.0 Selecting a Vehicle Seating Location

Lap Belts (Manually Adjusted) A lap belt that is manually adjusted and will remain tightly adjusted around the car seat while the vehicle is in motion is suitable for use with the car seat. Pulling the belt through the buckle after the buckle is fastened tightens this type of seat belt (Fig. 13a).



Fig. 13a

Lap Belts with Automatic Locking Retractor (ALR) A lap belt that cannot be lengthened once it is fastened is suitable for use with the car seat. These seat belts often have an automatic locking retractor (ALR) that will allow the belt to be lengthened but once fastened, must be unbuckled and allowed to retract fully before allowing the belt to be lengthened again (Fig. 13b).



Fig. 13b

Combination Lap/Shoulder Belt with Locking Latch Plate A lap/shoulder combination seat belt with a latch plate that locks the lap belt into position is suitable for use with the car seat (Fig. 13c). Once this type of seat belt is fastened, the latch plate prevents the lap belt from loosening. This combination seat belt does not require a Locking Clip.



Fig. 13c

4.0 Selecting a Vehicle Seating Location

Combination Lap/Shoulder Belt with Sliding Latch Plate A combination lap/shoulder belt with a latch plate that can slide freely along the belt (Fig. 14a), is suitable for use with this car seat when the belt is locked to prevent movement of the car seat. If the vehicle belt includes a lockable retractor, the retractor **MUST** be locked or a locking clip **MUST** be used. If the vehicle belt does not include a lockable retractor then a locking clip (Fig. 14b), **MUST** always be used.



Fig. 14a



Locking clip

Please refer to the vehicle owner's manual to determine if your vehicle lap/shoulder belt includes a lockable retractor and how to lock it.

Fig. 14b

4.0 Selecting a Vehicle Seating Location

4.4 Locking Clip Installation

Contact Baby Trend 1-800-328-7263 to acquire an approved Locking Clip. Locking Clip is stored under the seat cover of the car seat (Fig. 15a).

1. Route the combination lap shoulder belt through vehicle belt path on car seat and buckle vehicle seat belt.
2. Tighten the buckled seat belt by pulling upward on the shoulder belt while pushing down on the car seat.
3. While maintaining downward pressure on the car seat, squeeze the vehicle shoulder belt and lap belt together just above the buckle to prevent it from moving. Unbuckle the vehicle seat belt, being careful to prevent movement of the buckle.
4. Secure the vehicle shoulder belt to the lap belt by using the Locking Clip 1.25 cm (1/2") from the buckle (Fig. 15b).
5. Re-buckle the seat belt and check that the seat belt is tightly adjusted and stays tight. Ensure that locking clip is secure on both belts.

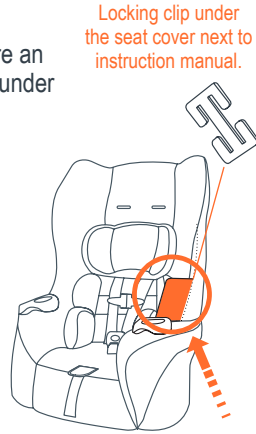


Fig. 15a

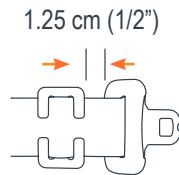


Fig. 15b

Test installation to make sure car seat is secure. If NOT secure, additional belt tightening is required. Repeat steps above until secure.

4.0 Selecting a Vehicle Seating Location

4.5 UNSAFE Vehicle Seat Belt Systems

DO NOT use the following types of seat belt systems with the car seat. These belt systems will not hold the car seat securely in place at all times. In addition, a Locking Clip used with this car seat will **NOT** make these belt systems safe to use. **NEVER USE** unsafe vehicle belts systems!

NOTE: UAS can be used **IN PLACE OF** the following unsafe vehicle seat belts systems if your vehicle is equipped with **UAS** anchorage system.

Lap Belts with Emergency Locking Retractor (ELR) **DO NOT** use a lap belt that stays loose after installed and locks only in a crash or sudden stop. These lap belts utilize an Emergency Locking Retractor (ELR) and are often found in combination with motorized shoulder belts. Because these belts will allow the car seat to move about on the vehicle seat, the chance of the car seat being out of the proper position in a crash is very high. Accordingly, **DO NOT** use the car seat with this type of seat belt system. Please see your vehicle's dealer or owner's manual for information on converting this seat belt system to one that is acceptable for use with a car seat (Fig. 16a).

Combination Lap/Shoulder Belt with Retractor

DO NOT use a lap/shoulder belt system if the lap belt and shoulder belt each have retractors at one end. This type of seat belt system will not adequately restrain the car seat (Fig. 16b).



Fig. 16a



Fig. 16b

4.0 Selecting a Vehicle Seating Location

Passive Restraint – Lap or Shoulder Belt Mounted on Door DO NOT use a seat belt that is connected to the door in any way. These types of seat belts are designed to automatically surround the occupant when the door is closed. This type of seat belt will **NOT** adequately restrain the car seat (Fig. 17a).



Fig. 17a

Passive Restraint – Lap Belt with Motorized Shoulder Belt DO NOT use a shoulder belt that moves along a track. These systems typically move to surround the occupant when the door is closed. This type of belt system will **NOT** adequately restrain the car seat (Fig. 17b).



Fig. 17b

Lap Belts Forward of Seat Crease DO NOT use a seat belt that is anchored on the seat more than 2 inches forward of the crease between the seat bottom and the seatback. This type of seat belt anchors the car seat too far forward and the car seat will not be safely restrained in the vehicle (Fig. 17c).



Fig. 17c

4.0 Selecting a Vehicle Seating Location

4.6 Preparation for Installation in Vehicle

When available, UAS is the recommended method of securing the car seat in the vehicle.

! WARNING!

DEATH or SERIOUS INJURY can occur:

- FAILURE TO PROPERLY SECURE THE CAR SEAT IN YOUR VEHICLE INCREASES THE RISK OF SERIOUS INJURY OR DEATH IN THE EVENT OF A SUDDEN STOP, SHARP TURN OR CRASH.
- Transport Canada alerts vehicle owners that, according to accident statistics, children under age 13 are safer when properly restrained in the rear seating positions rather than in front seating positions.
- Use car seats in a vehicle's rear seat location whenever possible.

1. Park your vehicle on a level surface so that the Seat Angle Indicator located on the left side of the car seat will properly indicate the proper angle of recline of the seat.



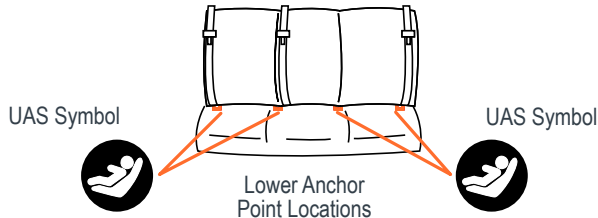
2. Make sure you have selected an acceptable location for the car seat as instructed in **Section 4.0 Selecting A Vehicle Seat Location**.

4.0 Selecting a Vehicle Seating Location

3. Check again for any active frontal air bags. **DO NOT** use a location that has an active frontal air bag or is adjacent to an Active Air bag such that, when deployed, the Active Air bag may come into contact with the car seat. Many passenger side frontal air bags are designed to deploy to protect the passenger side as well as the center front seating position. Please see the active air bag warnings in your vehicle owner's manual to help determine unsafe locations in the vehicle.
4. If the front seat position is used, slide the vehicle seat as far to the rear as possible to prevent the car seat from striking the dash in a crash. If the rear seat position is used, slide the vehicle seat directly in front of the car seat forward enough to prevent the car seat from striking the vehicle seatback in a crash.

4.7 Preparation for Installation with UAS Lower Anchor Belt

Consult your vehicle owner's manual or manufacturer for location and availability of UAS anchor points. **NOT all vehicles have the same locations or maximum weight requirements for UAS!**



4.0 Selecting a Vehicle Seating Location

4.8 Top Tether Anchor Locations

Top Tether Locations are indicated by the following symbol:



Top Tether symbol:

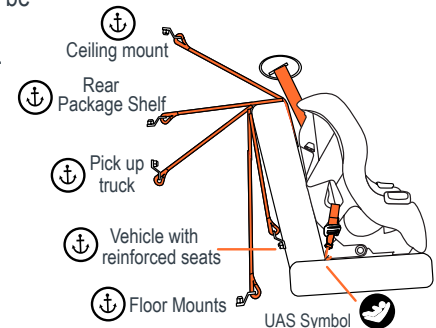


UAS

The Universal Anchorage System (UAS) is designed to make installation of child car seats easier by allowing child restraints to be installed without using the vehicle's seat belt system. Since September 1, 2002, at least two rear seating positions of all cars, mini vans, and light trucks come equipped with lower child restraint anchor points located between a vehicle's seat cushion and seat back. These vehicles are also equipped with at least 3 top tether anchorages located behind the vehicle seat. Together, the lower anchors and top tether make up the UAS. All child restraints manufactured since September 1, 2002 have lower anchor and top tether attachments which will connect to the vehicle's UAS. **Read your vehicle owner's manual for exact locations, identification and requirements for use with a child restraint. ONLY use UAS to secure your car seat in a seating position recommended by the vehicle manufacturer for UAS installation.** Refer to the vehicle owner's manual for the vehicle's top tether anchor locations. Vehicle anchorages should be identified by one of the symbols shown to the right.

Consult your vehicle owner's manual for your vehicle's exact UAS locations, anchor identification and usage requirements.

Vehicle Top Tether locations may vary:



5.0 Installation and Use

The American Academy of Pediatrics and Baby Trend recommend children remain in a rear-facing car seat as long as possible, until they reach the highest weight or height allowed by their seat.

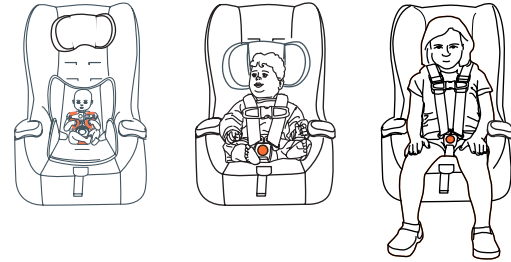
⚠️ WARNING!

DEATH or SERIOUS INJURY can occur:

- Use only in a rear facing position when using the car seat with an infant weighing less than 10 kg (22 lbs).
- Use only with children who weigh between 1.81 - 29 kg (4 - 65 lbs) and whose height is 127 cm (50 inches) or less.
- Rear Facing Installation - 1.8 to 18 kg (4 to 40 lb) - 102 cm (40 in) or less.
- Forward Facing Installation - 10.43 to 29 kg (23 to 65 lb) - 127 cm (50 in) or less.
- Snugly adjust the belts (Harness) provided with the car seat around your child. Snug means you can not pinch webbing once buckled.
- Secure this child seat with the vehicle's child restraint Anchorage system if available or with a lap/shoulder belt. This child restraint must be only used in a forward-facing seating position equipped with a vehicle seat belt or a lower universal anchorage system.
- Follow all instructions on the car seat and in the written instructions located in the pocket on the underside of the seat cover. Do not use without instructions. Call 1-800-328-7363 to obtain instructions.
- Register your car seat with Baby Trend.
- DO NOT place rear facing child seat in a front seat that has an active airbag.
- NEVER leave child unattended under any circumstance.
- Shoulder height adjustment position **1, 2 & 3** are for rear facing use only.
- Shoulder height adjustment position **3, 4 & 5** are for forward facing use only.
- Always adjust the recline foot to the **upright** position when forward facing.
- Always adjust the recline foot to the **recline** position when rear facing.

5.0 Installation and Use

5.1 Child Placement in The Car Seat

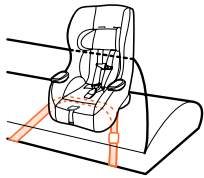


1. Place child in the car seat with the child's back flat against the back of the car seat and the child's bottom touching the seat.
2. Place harness straps over the child's shoulders.
NOTE: Check the height of the harness straps at the child's shoulders.
3. Place the crotch buckle in appropriate position. **See section 5.15 page 46.**
4. Insert the buckle tongues into the crotch buckle.
NOTE: Pull up and test buckle tongues to be sure they are secure.
5. Place chest clip at arm pit level. Insert chest clip tab and press together. Pull outward on chest clip's ends to be sure it is secure.
6. Pull on harness adjuster to tighten harness straps. A snug strap should not allow any slack. It lies in a relatively straight line without sagging. It does not press on to the child's skin or push the child's body into an unnatural position.

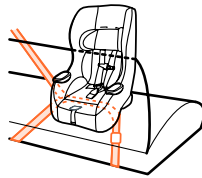
5.0 Installation and Use

5.1.1 Installation Diagrams

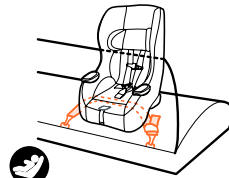
Routing paths for Rear Facing installation



Lap belt

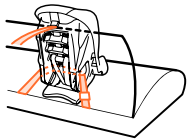


Lap/Shoulder belt

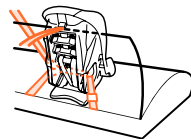


UAS Lower Connector

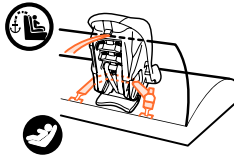
Routing paths for Forward Facing installation



Lap belt with top tether



Lap/Shoulder belt with top tether



UAS Lower Connector with top tether

⚠ WARNING!

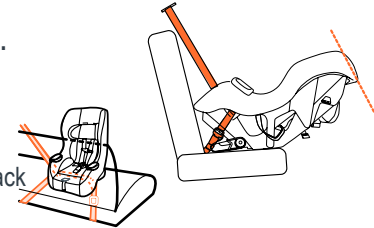
- Never use a Top Tether connector in a rear facing installation!!

5.0 Installation and Use

5.2 Rear Facing Installation with Lap/Shoulder Belt

See section 2.1 for requirements.

- Weight 1.8 - 18 kg, (4 and 40 lbs)
- Height is 102 cm (40 in) or less.
- Top of head has **NOT** reached 25.4 mm (1 in) from top of seatback

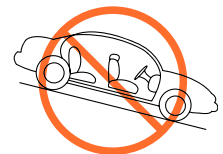


Lap/Shoulder belt

1. Always adjust the recline foot to the recline position when rear facing. Angling the car seat will keep the baby's head back and airway open.



2. Make sure vehicle is parked on level ground then, place the car seat in a rear seating position and ensure vehicle is level.



3. Route Lap/Shoulder Belt through the rear facing belt paths and under the seat fabric.

NOTE: Remove any twist in webbing to ensure the webbing lies flat before securing the car seat to the vehicle.

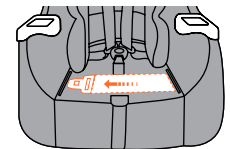


Fig. 24a

5.0 Installation and Use

- Use body weight or apply weight in seat with hand to compress the vehicle seat cushion then insert the seat buckle tongue into the buckle and pull seat belt tight as possible (Fig. 25a). Pull excess webbing at buckle tongue to tighten.
- Pull up on buckle to ensure the buckle is secure. Please refer to the vehicle owner's manual to determine if your vehicle lap/shoulder belt includes a lockable retractor and how to lock it.
- Ensure the angle indicator bubble is centered between the lines for children to keep the child's airway open. Recheck after child is secured in seat (Fig. 25b).
- Check for movement of the car seat at the safety belt path. The car seat should not move more than 1 inch (2.54 cm) in any direction. If the car seat moves more than 1 inch (2.54 cm), repeat all steps until all safety steps are met.

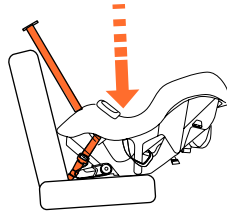


Fig. 25a

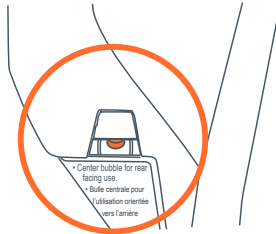


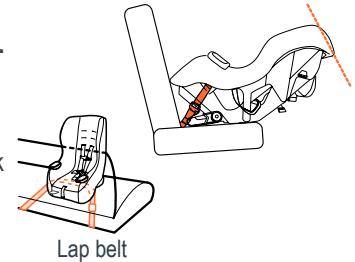
Fig. 25b


5.0 Installation and Use

5.3 Rear Facing Installation with Lap Belt.

See section 2.1 for requirements.

- Weight is 1.81 - 18 kg (4 - 40 lbs).
- Height 102 cm (40 in) or less.
- Top of head has NOT reached 25.4 mm (1 in) from top of seatback



- Always adjust the recline foot to the recline position when rear facing. Angling the car seat will keep the baby's head back and airway open. 
- Make sure vehicle is parked on level ground then, place the car seat in a rear seating position and ensure vehicle is level.



- Route Lap Belt through the rear facing belt paths and under the seat fabric (Fig. 26a). **NOTE:** Remove any twist in webbing to ensure the webbing lies flat for securing the car seat to the vehicle.

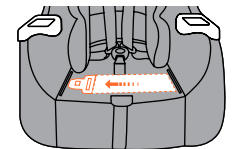


Fig. 26a

5.0 Installation and Use

- Use body weight or apply weight in seat with hand to compress the vehicle seat cushion then insert the seat buckle and pull seat belt tight as possible (Fig. 27a). Pull excess webbing at buckle tongue to tighten.
- Pull up on buckle to ensure the buckle is secure.
- Ensure the angle indicator bubble is centered between the lines for children to keep the child's airway open. Recheck after child is in seat (Fig. 27b).
- Check for movement of the car seat at the safety belt path. The car seat should not move more than 25.4mm (1 inch) in any direction. If the car seat moves more than 25.4mm (1 inch), repeat all steps until all safety steps are met.

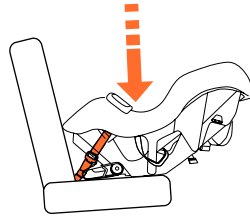


Fig. 27a

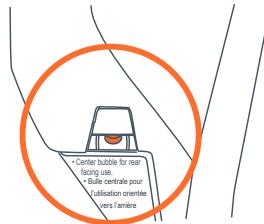


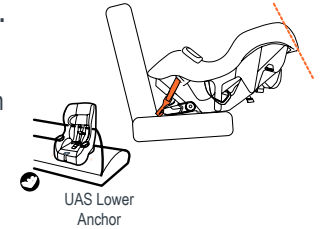
Fig. 27b

5.0 Installation and Use

5.4 Rear Facing Installation with UAS Lower Connectors

See section 2.1 for use requirements.

- Weight is 1.81 - 18 kg, (4 - 40 lbs).
- Height is 102 cm (40 in) or less.
- Top of head has NOT reached 2.54 cm (1 in) from top of seatback
- Place this car seat in a rear seating position designated as UAS Lower Connector compatible. Refer to your vehicle owner's manual for UAS locations.



- Always adjust the recline foot to the recline position when rear facing. Angling the car seat will keep the baby's head back and airway open.
- Make sure vehicle is parked on level ground then, place the car seat



in a rear seating position and ensure vehicle is level.

- Route **UAS** Lower Connector through the rear facing belt paths and under the seat fabric (Fig. 28a).

NOTE: Remove any twist in webbing to ensure the webbing lies flat for securing the car seat to the vehicle.

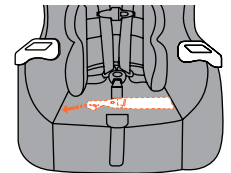


Fig. 28a

5.0 Installation and Use

- Use body weight or apply weight in seat with hand to compress the vehicle seat cushion then insert the UAS lower connector onto the vehicle anchor point (Fig. 29a). Tighten the UAS lower connector by pulling up on the webbing end through opening in seat fabric (Fig. 29b). Pull up on the lower UAS lower connector to ensure the UAS lower connector is securely fastened (Fig. 29c).

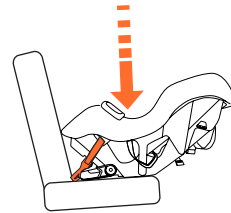
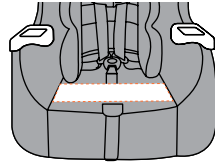


Fig. 29a

- Ensure the angle indicator bubble is centered between the lines for children to keep the child's airway open. Recheck after child is secured in seat (Fig. 29c).

- Check for movement of the car seat at the safety belt path. The car seat should not move more than 25.4mm (1 inch) in any direction. If the car seat moves more than 25.4mm (1 inch), repeat all steps until all safety steps are met.



Fig. 29b

- See page 49, 5.19 UAS / Top Tether Removal for removal of UAS / Top Tether.

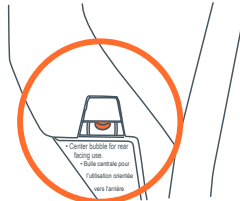


Fig. 29c

5.0 Installation and Use

5.5 Forward Facing Installation with Lap/shoulder Belt and Top Tether

See section 2.2 for requirements.

- Weight is 10.43 - 29 kg (23 - 65 lbs).
- Height is 127cm (50 inches) or less.
- Age is 1 year old.

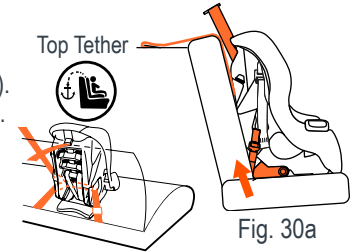
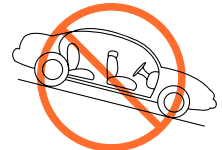
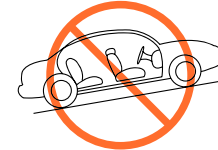


Fig. 30a

- Place this car seat in a rear seating position. Always adjust the recline foot to the upright position when forward facing.
- Ensure vehicle is level and that the car seat is placed flat, and rests on the front outer edge of the vehicle seat.



- Loosen harness by pressing the center adjuster and pulling on harness. Pull top of seat fabric down to expose the forward facing belt path (Fig. 30a).

NOTE: Remove any twist in webbing to ensure the webbing lies flat for securing the car seat to the vehicle.

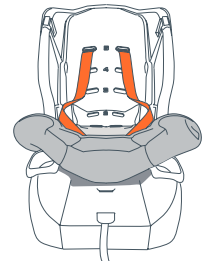


Fig. 30b

5.0 Installation and Use

- Route seat belt through forward facing belt path (Fig. 31a).
- Put weight in seat with hand to compress the vehicle seat cushion then insert the buckle tongue into the buckle and adjust seat belt as tight as possible (Fig. 31b).
- Pull seat fabric up and over the top of the car seat. Then, install the pillow (Fig. 31c).
- Pull up on buckle as to ensure the buckle is secure. Please refer to the vehicle owner's manual to determine if your vehicle lap/shoulder belt includes a lockable retractor and how to lock it.
- Always attach Top Tether to a designated anchor point. Pull Top Tether strap until webbing strap is snug (Fig. 31d).
NOTE: Your vehicle owner's manual will give the anchor locations and maximum weight of the car seat's occupant for UAS connections.
- Check for movement of the car seat at the safety belt path. The car seat should not move more than 25.4mm (1 inch) in any direction. If the car seat moves more than 25.4mm (1 inch) repeat all steps until all safety steps are met.

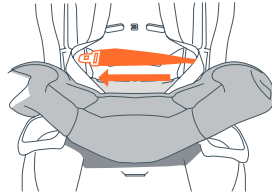


Fig. 31a



Fig. 31b

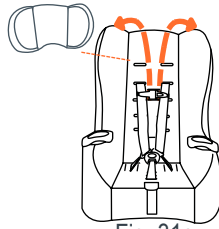


Fig. 31c



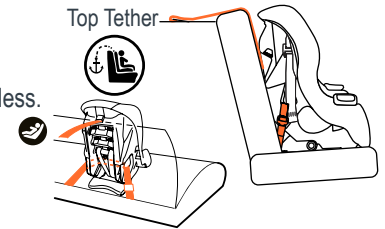
Fig. 31d

5.0 Installation and Use

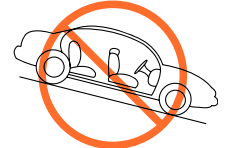
5.6 Forward Facing Installation with Lap Belt and Top Tether

Requirements. See section 2.2:

- Weight is 10.43 - 29 kg (23 - 65 lbs)
- Height is 127 cm (50 inches) or less.
- Age is 1 year old.



- Place the car seat in a rear seating position. Always adjust the recline foot to the upright position when forward facing.
- Ensure vehicle is level and that the car seat is placed and rests on the front outer edge of the vehicle seat.



- Loosen harness by pressing the center adjuster and pulling on harness. Pull top of seat fabric down to expose the forward belt path (Fig. 32a).

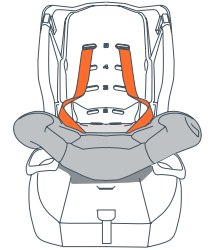


Fig. 32a

5.0 Installation and Use

4. Route seat belt through forward facing belt path (Fig. 33a).

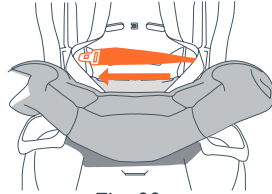


Fig. 33a

5. Put weight in seat with hand to compress the automobile seat cushion then insert the buckle tongue into the buckle and adjust seat belt as tight as possible (Fig. 33b).

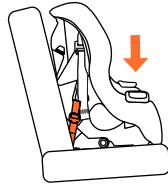


Fig. 33b

6. Pull seat fabric up and over the top of the car seat. Then, install the pillow (Fig. 33c).

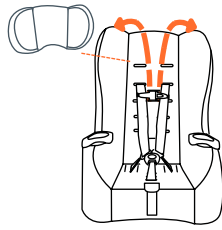


Fig. 33c

7. Pull up on buckle as to ensure the buckle is secure.

8. Always attach Top Tether to a designated anchor point. Pull Top Tether strap until webbing strap is snug (Fig. 33d).

NOTE: Your vehicle owner's manual will give the anchor locations and maximum weight of the car seat's occupant for UAS connections.

9. Check for movement of the car seat at the safety belt path. The car seat should not move more than 25.4mm (1 inch) in any direction. If the car seat moves more than 25.4mm (1 inch) repeat all steps until all safety steps are met.



Fig. 33d

5.0 Installation and Use

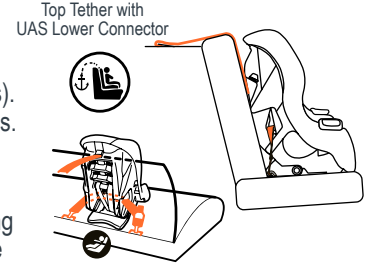
5.7 Forward Facing Installation with UAS Lower Connector and Top Tether

See section 2.2 for requirements.

- Weight is 10.43 - 29 kg (23 - 65 lbs).
- Height is 127 cm (50 inches) or less.
- Age is 1 year old.

1. Place the car seat in a rear seating position. Always adjust the recline foot to the upright position when forward facing.

2. Ensure vehicle is level and that the car seat is placed and rests on the front outer edge of the vehicle seat.



3. Loosen harness by pressing the harness adjuster and pulling on harness. Pull top of seat fabric down to expose the forward facing belt path (Fig. 34a).

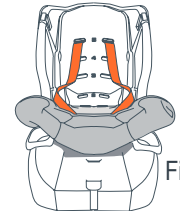


Fig. 34a

5.0 Installation and Use

4. Route UAS lower connectors through forward facing belt path (Fig. 35a).
5. Put weight in seat with hand to compress the vehicle seat cushion then insert the lower anchor connector on to the vehicle connector anchor point. Tighten the UAS lower anchor connector by pulling up on the webbing end. Pull up on the UAS lower connector to ensure the UAS lower connector is securely fastened (Fig. 35b).
6. Pull seat fabric up and over the top of the car seat. Then, install the pillow (Fig. 35c).
7. Always attach Top Tether to a designated anchor point. Pull Top Tether strap until webbing strap is snug (Fig. 35d). **NOTE: Your vehicle owner's manual will give the anchor locations and maximum weight of the car seat's occupant for UAS connections.**
8. Check for movement of the car seat at the safety belt path. The car seat should not move more than 25.4mm (1 inch) in any direction. If the car seat moves more than 25.4mm (1 inch) repeat all steps until all safety steps are met.
9. See page 49, 5.19 UAS / Top Tether Removal for removal of UAS / Top Tether.

5.8 Aircraft installation

1. Follow the Lap Belt installation in sections 5.3 and 5.6 for use in an Aircraft with the exception of top tether installation.
2. Consult your airline for requirements to use the car seat.

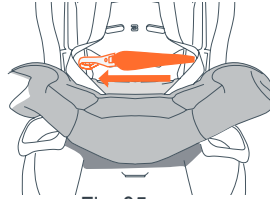


Fig. 35a

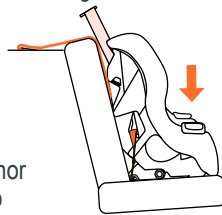


Fig. 35b

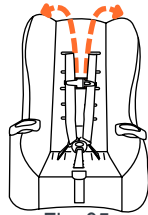


Fig. 35c



Fig. 35d

5.0 Installation and Use

5.9 Child Placement In The Car Seat

1. Place child in the car seat with the child's back against the back of the car seat and the child's bottom touching the seat (Fig. 36a).
2. Rear Facing - Harness Strap should be located in the nearest position at or below the shoulder (Fig. 36b).

Forward Facing - Harness Strap Height should be located in the slot at or slightly above the child's shoulder (Fig. 36c).

NOTE: Use slots 3, 4 and 5 for forward facing.

Then place harness straps over the child's shoulders (Fig. 36d).

3. The car seat has been safety tested with the seat insert and pillow (Fig. 36e) that are included with this car seat. **DO NOT use pillow if child's head falls forward.**

- Head Pillow can be used in Forward and Rear facing
- **ONLY** use the seat insert with children who weigh between 1.81 - 8.16 kg (4-18 lbs). Rear facing use only.

Top Ears Max Height ←



Fig. 36a



Fig. 36b

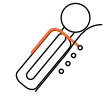


Fig. 36c



Fig. 36d



Fig. 36e

5.0 Installation and Use

4. Insert the buckle tongues into the buckle (Fig. 37a).
NOTE: Pull up and test buckle tongues to be sure they are secure.
5. Place chest clip at arm pit level (Fig. 37b). Insert chest clip tabs and press together. Pull outward on chest clip's ends to be sure it is secure.
6. Pull on the harness tension adjuster to tighten harness straps. The strap should not allow any slack (Fig. 37c). The strap should not press on to the child's skin or push the child's body into an unnatural position. Harness Covers are required in all forward facing and rear facing position except the Low Birth weight harness routing.

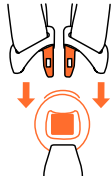


Fig. 37a



Fig. 37b

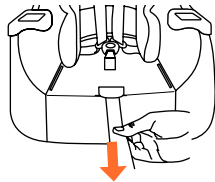


Fig. 37c

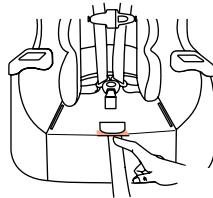


Fig. 37d

To Loosen Harness System Tension, push the harness tension adjuster button (Fig. 37d) located underneath the seat fabric and gently pull over the harness straps over the child's shoulder.

5.0 Installation and Use

5.10 Shoulder Harness Height Adjustment

1. **Shoulder Height Positions**
Rear Facing: Positions **1, 2 and 3**.
Forward Facing: Positions **3, 4 and 5** (Fig. 38a).
Height Adjustment

1. Loosen harness, unfasten harness end loops from splitter plate. Pull harness end loops through seatback. Thread harness end loops through desired shoulder slot position (Fig. 38b).
2. Fasten harness end loops to splitter plate. Ensure the harness strap ends are fully hooked on the splitter plate. Both sides must be threaded in the same position (Fig. 38c).

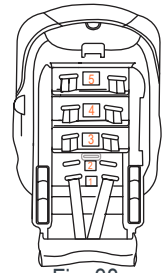


Fig. 38a

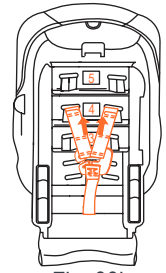


Fig. 38b

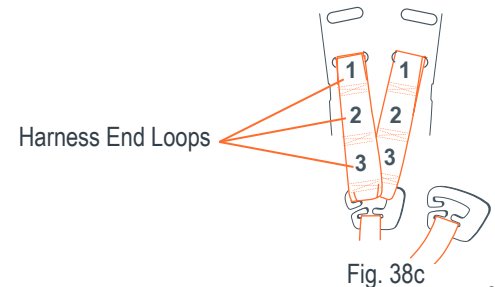


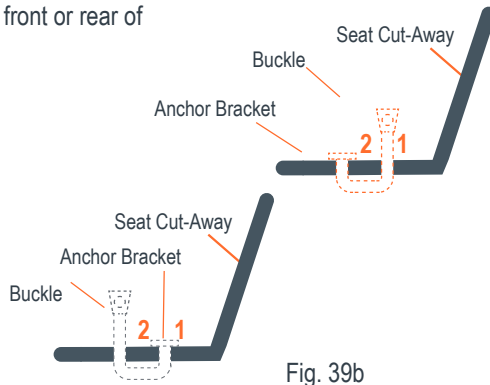
Fig. 38c

5.0 Installation and Use

5.11 Crotch Buckle Adjustment

For children 10kg (22 lbs) or less, the crotch strap length should be adjusted such that a gap of 12.7mm (1/2" inches) to 25.4mm (1 inches) is present between the ears of the buckle, and the top of the child's thigh, disregarding any clothing or diaper (Fig. 39a). Your child will grow very quickly so always check that the buckle is the proper height whenever placing your child in the Safety seat. The crotch strap length is adjusted as follows:

1. To shorten the length of the buckle webbing, place the anchor bracket through the slot in front or rear of buckle (Fig. 39b).



5.0 Installation and Use

5.12 Seat Fabric Removal And Laundering

Seat Fabric Removal

1. Unfasten harness end loops from metal plate and pull harness through the seatback.
 - Unbuckle crotch buckle.
 - Unbuckle chest clip.(Fig. 40a).
2. Pull up and out on seat fabric and feed harness, buckle tongues and chest clip through slots on seat fabric (Fig. 40b).
3. Slip seat fabric over cup holders (Fig. 40c).
4. To clean only use mild soap or detergent and warm water on a sponge or clean cloth.

- Do Not machine wash.
- Do Not dry clean
- Do Not bleach
- Do Not iron.

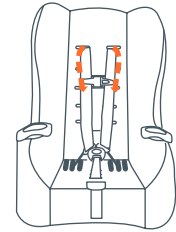


Fig. 40a

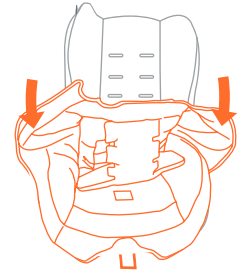


Fig. 40b

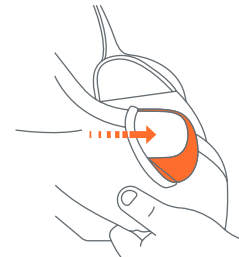


Fig. 40c

5.0 Installation and Use

5.13 Low Birth Weight Harness Shortening Routing

1. Remove the head pillow and set aside (Fig. 41a).
2. Remove the harness loops ends from the splitter plate and pull harness through the seat back. See section (5.10 Page 38).
3. Remove harness cover, chest clip and buckle tongue on one side and set aside. Remove the cup holders and set aside (Fig. 41b).
4. Pull harness webbing through the seat insert. Remove the seat insert and set aside (Fig. 41d).
5. Lift seat fabric from the top and pull crotch buckle through while removing the complete seat fabric.
6. Must use crotch buckle in position 1. Always put crotch buckle and place into position 1 (Fig. 41c).
7. Pull the crotch buckle anchor through to position 2 (Fig. 41c).

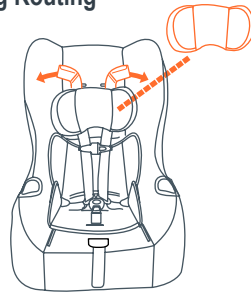


Fig. 41a

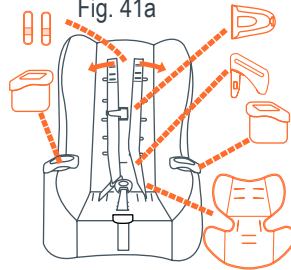


Fig. 41b

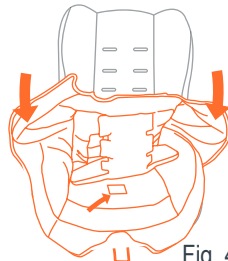


Fig. 41d

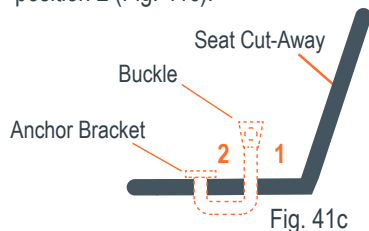
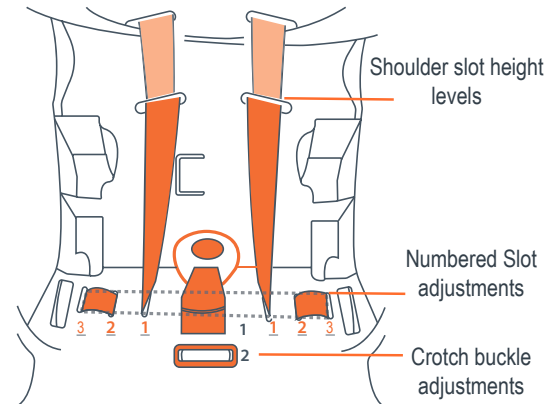


Fig. 41c

5.0 Installation and Use

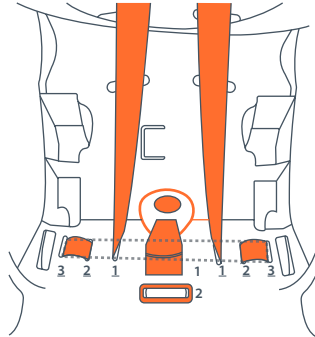
5.13 Low Birth Weight Harness Shortening Routing cont.

8. From top side feed harness loop down through bottom of seat slot (1).
9. Turn car seat over and feed harness loop end back through slot (2).
10. Turn car seat upright and feed through harness slot (3).
11. On opposite side, Turn seat over and feed harness loop through slot number (3).
12. From top side feed harness loop end down through slot number (2).
13. Turn seat over and feed harness end up through slot number (1).



5.0 Installation and Use

5.13 Low Birth Weight Harness Shortening Routing cont.



14. From the top side pull harness end loop to pull excess webbing from bottom side.
15. Grasp both sides of harness end loops and pull up to equalize the harness length.
16. Ensure the harness end loops are the same length.
17. If harness length is not equal, pull webbing from long side of webbing to equalize length.
18. Place seat fabric on shell threading harness end loops through the inner most slots on the bottom seat fabric.

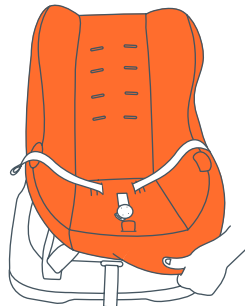


Fig. 43a

5.0 Installation and Use

5.13 Low Birth Weight Harness Shortening Routing cont.

19. Thread buckle through the seat fabric.
20. Install seat insert. Seat insert use is not required.
21. Insert buckle tongue into crotch buckle on child's left side.
22. Feed harness end loop from the back side of the buckle tongues (Fig. 44a).
23. Feed chest clip through harness end loop on child's left side (Fig. 44a).
24. Pull up on webbing end loops to ensure the webbing end loops are equalized (Fig. 44a).
25. Feed harness end loops and crotch buckle through appropriate slots on seat insert.
26. Thread harness end loops through appropriate slot No. 1 or 2. Shoulder harness must at or below child's shoulder.
27. Thread harness end loops number 1 (inner most) through splitter plate.
28. **DO NOT** use harness covers with Low Birth Weight Routing.
29. **DO NOT** use pillow with Low Birth Weight Routing.
30. Place child in seat and confirm harness is at or below child's shoulder.

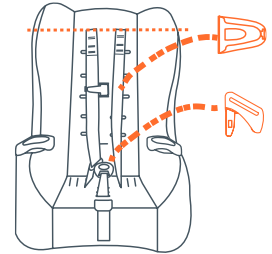


Fig. 44a

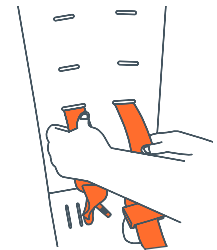
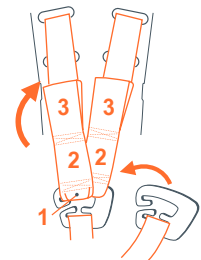


Fig. 44b



5.0 Installation and Use

5.13 Low Birth Weight Harness Shortening Routing cont.

31. Place child in car seat **with** seat insert, **without** pillow and harness covers.
- NEVER** use pillow or harness covers in the Low Birth Weight Harness Routing (Fig. 45a).

NOTE: Pillow can be stored / attached in harness position #5 when not in use.

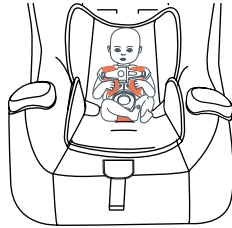


Fig. 45a

32. Place child in car seat **without** seat insert, pillow and harness covers.

NEVER use pillow or harness covers in the Low Birth Weight Harness Routing (Fig. 45b).

NOTE: Pillow can be stored / attached in harness position #5 when not in use.

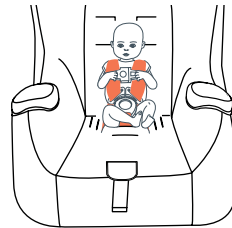


Fig. 45b

5.14 Pillow, Seat Insert and Harness Covers Use

1. Pillow Use

- Use is not mandatory
- **DO NOT** use in the Low Birth Weight Harness Routing option.
- **DO NOT** use Pillow and Harness in same harness slot. Discontinue use when the child requires use of harness position 5.



Pillow

5.0 Installation and Use

5.14 Pillow, Seat Insert and Harness Covers Use cont.

2. Seat Insert Use

- Use is not mandatory.
- **YOU MAY** use in the Low Birth Weight Harness Routing option.
- **ONLY** use the seat insert with children who weigh between 1.81 - 8.16 kg (4-18 lbs).
- Rear facing use only.



Seat Insert

3. Harness Covers

- **DO NOT** use in the Low Birth Weight Harness Routing option.
- **Must Be Used In All Other Modes.**



Harness Covers

5.15 Harness Hip and Buckle Use Positions

Crotch Buckle Use Positions:

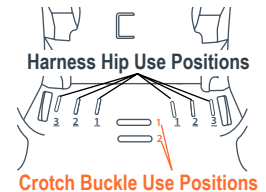
- 1- Rear Facing use.
- 2- Forward and Rear facing use.

NOTE: The Crotch Buckle should be at the crotch but not under.

Harness Hip Positions:

- 1- Low Birth Weight Harness Shortening Routing Only.
- 2- Up to 18 kg (40 lbs).
- 3- Above 18 kg (40 lbs).

NOTE: The Harness should be at or out from the hip but not under.



5.0 Installation and Use

5.16 Cup holders Removal, Installation and Cleaning.

Removal

- Using a Phillips screwdriver, remove the screw and washer from the bottom side of the cup holder (Fig. 47a).
- Place them in a safe location, out of reach of children. Repeat the process on the other side.
- Press tab on bottom of cup holder to release cup holders and pull up to remove (Fig. 47b).



Fig. 47a

Installation

- Pull car seat cover back to expose cup holders receptacle (Fig. 47b).
- Align cup holders and press into place. Pull up on cup holders to ensure the cup holders is secured (Fig. 47c).

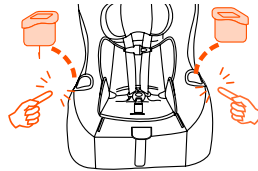


Fig. 47b

- Fit the car seat cover over the front of the cup holder, ensuring it is properly positioned. Then, secure the car seat cover over the cup holder (Fig. 47d). Repeat this process for the other side. Using a Phillips screwdriver, install the screw and washer (Fig. 47e). Repeat the process on the other side.

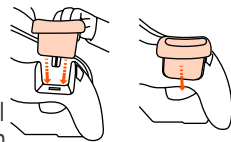


Fig. 47c

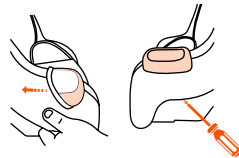


Fig. 47d

Fig. 47e

Cleaning

- Wipe with mild solution of soap and water.
- Rinse with clean water.
- Never use "household" detergents or solvents.

5.0 Installation and Use

5.17 Securing Pillow

1. Insert pillow attachment straps through the appropriate shoulder belt position (Fig. 48a).
2. Secure attachment straps with the hook and loop fasteners (Fig. 48b).

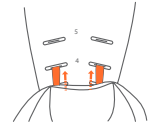


Fig. 48a

5.18 Pool Noodle or Rolled Towel Use Extra Elevation

1. A pool noodle or rolled towel can be used for extra elevation.
2. Place the noodle or rolled towel where the child car seat bottom and vehicle seat back meet for additional recline elevation (Fig. 48c).
3. Place the noodle or rolled towel at back of the child car seat bottom for additional incline elevation (Fig. 48d).
4. Multiple pool noodles or towels may be secured together for elevation (Fig. 48e).



Fig. 48b



Fig. 48c



Fig. 48d



Fig. 48e

5.0 Use and Installation - 6.0 Safety

5.19 UAS or Top Tether Removal

To remove the car seat from the vehicle, squeeze the webbing tension release button on the UAS lower connector or Top Tether to loosen the webbing (Fig. 49a). Please note that the UAS lower connector or Top Tether can not be released from the UAS or Top Tether anchor point if the webbing is tight. Press the UAS lower connector or Top Tether release button on each connector to release the connector from the anchor point (Fig. 49b).



Fig. 49a



Fig. 49b

6.1 Safety Checklist:

- ✓ Did you read and understand these instructions and labels on the car seat?
- ✓ Is the child the proper weight and height for the seat in the rear facing position?
- ✓ If the child is in the rear facing position, are the shoulder straps at or below the child's shoulders?
- ✓ Have you checked the proper seat angle for the rear facing position?
- ✓ Is the child the proper weight and height for the seat in the forward facing position?
- ✓ If the child is in the forward facing position, are the shoulder straps at or above the child's shoulders?
- ✓ Did you pull the harness adjuster tight? You should not be able to pinch the harness if the harness is properly tightened.
- ✓ Is the car seat buckled in the automobile with either the UAS system or the auto safety belt system?
- ✓ Discontinue use of this Car seat after 7 years from the date of manufacture printed on the label on the bottom of the seat.
- ✓ Has the airbag been deactivated in a vehicle with a front only seat.

7.0 Additional Information

Please Drive Safely

7.1 Certification

This Car Seat is certified for use in Motor Vehicles and Aircraft and conforms to all applicable Canadian Motor Vehicle Safety standards (213 and 213.1).

7.2 Aircraft Use:

This Restraint is Certified for Use in Aircraft.

7.3 Vehicle Seat Protection:

Protect vehicle seat. Use a thin car seat mat, thin towel, or thin blanket under and behind the Car seat.

7.4 Instruction Manual Storage:

Store this manual in the pocket provided on the underside of the seat cover.

7.5 Car Seat Useful Life:

DO NOT use this Car seat after date on bottom of seat. Parts may be missing, damaged, or the Car seat may have been in a crash.

Registration Information

REGISTER YOUR CAR SEAT

Please complete the following information. The model number and manufactured in (date) can be found on a label on the bottom of the Car seat.

Model Number: _____

Manufactured in: _____

Purchase Date: _____

Please fill out the prepaid registration post card attached to the harness straps and mail it today.

Car seats could be recalled for safety reasons. You must register the car seat to be reached in a recall. Send your name, address, e-mail address if available, and the car seat's model number and manufacturing date to:

Baby Trend®, Inc, 13048 Valley Blvd. Fontana CA 92335 or call 1-800-328-7363 or register online at <http://www.babytrend.com/registration.html>. For recall information, call Transport Canada at 1-800-333-0371 (toll free), 613-998-8616 (Ottawa area) or go to <http://www.tc.gc.ca/eng/roadsafety/safedrivers-childsafetynotices-menu-907.htm>.

If You Need Help

Please contact our Customer Service Department with any questions concerning your car seat. When you contact us, please have the model and manufactured in (date) ready. The model number and manufactured in (date) can be found on a white label located on the bottom of the car seat.

USA Toll Free: **1-800-328-7363**

8:00 a.m. to 4:30 p.m. (PST) Monday - Friday

or www.babytrend.com

9.0 Care and Cleaning

9.1 Removing The Seat Fabric, Insert and Pillow:

- Follow directions in section 5.12.

9.2 Cleaning The Seat Fabric, Insert and Pillow:

- To clean only use mild soap or detergent and warm water on a sponge or clean cloth.

- **Do Not machine wash.**
- **Do Not dry clean**
- **Do Not bleach**
- **Do Not iron.**

9.3 Cleaning Car Seat Parts and Buckles:

- Wipe with mild solution of soap and water. Avoid wetting labels.
- Rinse with clean water.
- Never use "household" detergents or solvents.

9.4 Replacement Parts

If You Need Help or Replacement Parts, please call our Customer Service Department at 1-800-328-7363 between the hours of 8:00 am and 4:30 PM, Pacific Time, Monday through Friday or visit us online at www.babytrend.com

10.0 Warranty

WARRANTY

DO NOT RETURN YOUR PRODUCT TO THE STORE. PLEASE CONTACT BABY TREND® FOR REPLACEMENT PARTS, SERVICE AND REPAIR.

The Baby Trend® warranty covers workmanship defects within the first 180 days of purchase. Any product which has been subjected to misuse, abuse, abnormal use, excessive wear and tear, improper assembly, negligence, environmental exposure, alteration or accident, or has had its serial number altered or removed invalidates all claims against the manufacturer. Any damage to property during installation is the sole responsibility of the end user. The Customer Service Department can be contacted at 1 (800) 328-7363 Monday through Friday between 8:00 a.m. and 4:30 p.m. (PST). Return Authorizations are required prior to returning product(s) to Baby Trend®.

10.0 GARANTIA

GARANTIA

NO DEVUELVA SU PRODUCTO A LA TIENDA. POR FAVOR CONTACTE A BABY TREND® PARA PIEZAS DE REPUESTO, SERVICIO Y REPARACION.

La garantía de Baby Trend® cubre defectos de fábrica dentro de los primeros 180 días de la compra. Cualquier producto que haya sido sometido a uso indebido, abuso, uso anormal, desgaste excesivo, montaje incorrecto, negligencia, exposición ambiental, alteración o accidente, o que ha tenido su número de serie alterado o removido anula todos los reclamos contra el fabricante. Cualquier daño a la propiedad durante la instalación es de la exclusiva responsabilidad del usuario final. El Departamento de Servicio al Cliente puede ser contactado a 1 (800) 328-7363 Lunes a viernes entre 8:00 a.m. y 4:30 p.m. (PST). Un número de autorización es requerido antes de la devolución de los producto(s) a Baby Trend®.

10.0 GARANTIE

GARANTIE

NE PAS RETOURNER VOTRE PRODUIT AU MAGASIN.

VEUILLEZ CONTACTER BABY TREND® POUR DES PIÈCES DE RECHANGE, ENTRETIEN ET RÉPARATION.

La garantie Baby Trend® couvre les vices de fabrication dans les 180 jours suivant l'achat du produit. Tout produit qui a été soumis à un usage abusif, une utilisation anormale, une usure excessive, un montage incorrect, de la négligence, de l'exposition environnementale, de la modification ou un accident, ou a eu son numéro de série modifié ou supprimé annule toutes les réclamations contre le fabricant. Tout dommage à la propriété lors de l'installation est de la seule responsabilité de l'utilisateur final. Le service client peut être contacté au 1 (800) 328-7363 du lundi au vendredi 8 h – 16 h 30 (PST). Une autorisation sera nécessaire avant de retourner le produit à Baby Trend®.

